



EUROPEAN BRIDGE LEAGUE



13th EBL/WBF Max Bavin Tournament Directors Course
27th to 30th of November 2025
Warsaw, Poland

Simulations



Board 1.

North/None

	♠ 9 5 4										
	♥ 9 7										
	♦ 10 7 2										
	♣ A J 7 5 3										
♠ 10 7	<table style="width: 100%; text-align: center;"> <tr><td></td><td>N</td><td></td></tr> <tr><td>W</td><td></td><td>E</td></tr> <tr><td></td><td>S</td><td></td></tr> </table>		N		W		E		S		♠ A K Q 3
	N										
W		E									
	S										
♥ 8 6 2		♥ K Q J 3									
♦ 9 5 4 3		♦ A Q J 6									
♣ K Q 8 4		♣ 10									
	♠ J 8 6 2										
	♥ A 10 5 4										
	♦ K 8										
	♣ 9 6 2										

West	North	East	South
	Pass	2♦	Pass
2♥	Pass	2NT	
			Pass
3NT	All pass		

2♦ explained as either weak major or 3-suited strong.

- A) Before his pass, South asked about 2NT. West says, "2NT meant something, but I forgot." TD!
- B) South asked about the meaning of 2NT after the auction, before his lead. West replied, "First time playing. We agreed on 2♦ opening, but we never discussed all responses.
- C) As in B), but the answer was "2NT meant something, but I forgot." Getting this explanation, South led a spade. When a card was played from dummy, North asked declarer about 2NT, and he said "4441". South called the TD. And called again after the play ended.



Board 2.

East/NS

In all examples, South immediately corrects his call. West calls TD.

A)

	West	North	East	South
			1♠	1♥ /1NT

(S: ♠AJ9 ♥K6 ♦AQ87 ♣Q1063)

When asked, South says he meant to bid 1NT, but 1♥ came out by mistake.

B)

	West	North	East	South
			1♠	1♥ /2♥

(S: ♠95 ♥AKJ86 ♦Q1087 ♣K3)

When asked, South says he tried to open bidding, but seeing 1♠, he bid 2♥.

C)

	West	North	East	South
			1♥	1♠ /1NT

(S: ♠A9543 ♥KJ8 ♦AJ7 ♣K3)

South tried to open 1♠ but doesn't confess at first. When TD asks in detail, he understands the situation.



Board 3.

South/EW

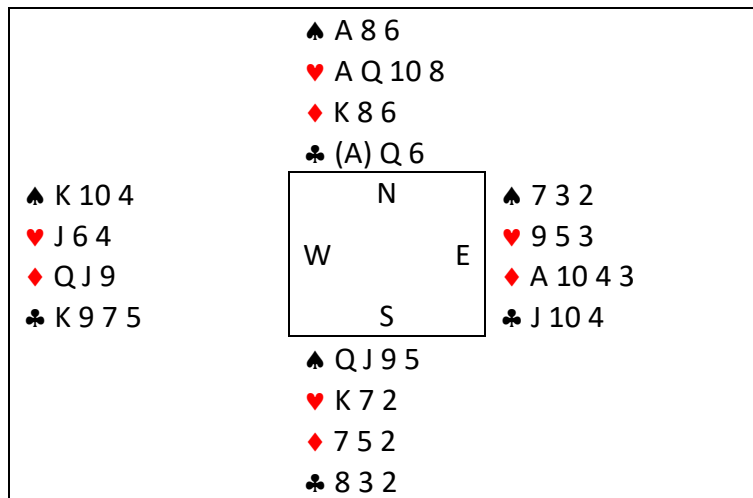

West	North	East	South
Pass	1NT		Pass

- A) After bidding 1NT (15-17), North realizes he has only 12 cards and calls the TD. The card (♣A) is found face down on the floor. After the card is returned to his hand, North asks the TD if he is allowed to change his call.
If the TD does not allow North to change his call, South bids 2NT and North raises to 3NT. After a diamond lead, 9 tricks are made. EW are not happy with South bidding 2NT on 6hcp and calls the TD.
- B) Once again, North realizes he has only 12 cards after bidding 1NT. When the TD looks for the missing card South realizes he has 14 cards (including the ace of clubs he should not have). After the TD has given North his ace of clubs, South bids 2NT, and the continuation is as in A above.
- C) The bidding ends in 1NT. East leads the ♣J to North's queen. North plays 4 rounds of hearts (everybody discarding a diamond on the 13th heart). North now plays ♠6 to jack, and West wins with the king. West plays low club to East's jack, and East continues a club to West's king (North discarding a diamond). When North plays his last club, everybody discards again, and now West asks what has happened to the ace of clubs? The card again is found on the floor. TD!



Board 4.

West/Both

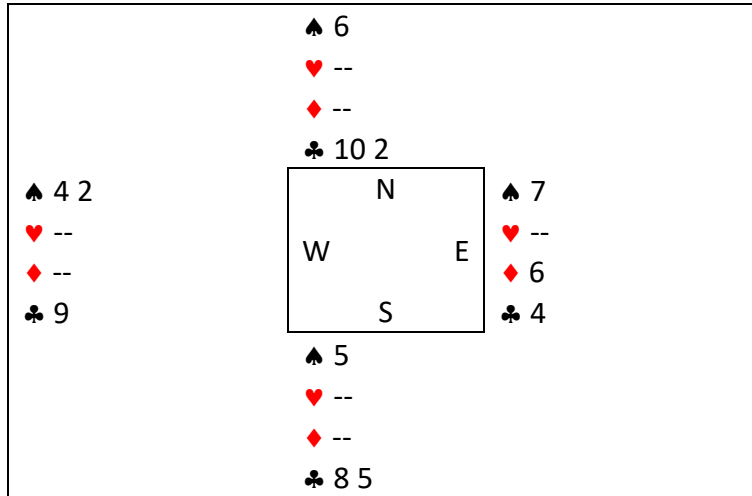

3NT E declarer has taken 9 tricks so far.

- A) East cashes the diamond. South throws a club, North throws a spade. North thinks a spade winner is in South. North says, "The last two are ours." East, who doesn't know spade seven is good, accepts. When writing the score, East realizes spade seven is good, calls TD and says that if the play had continued, most likely would have played spade.
- B) East plays the diamond. South throws a club, North throws a spade. North thinks a spade winner is in South. North says, "The last two are ours." East, who doesn't know spade seven is good, accepts. After East passes in the next board, West asks who has the spade seven. East calls TD and says that if the play had continued, most likely would have played a spade.
- C) East shows the diamond and says +1. A few seconds later, says, "Wait, spade seven is good, I think", and claims +2. Decision?



Board 5.

North/NS

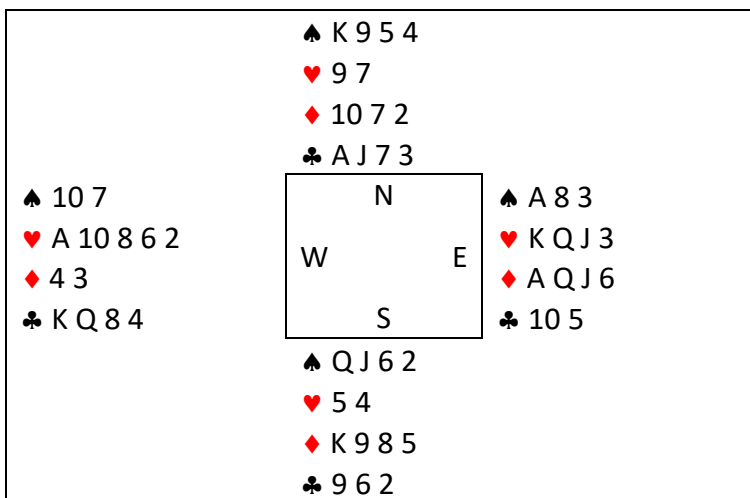

West	North	East	South
	Pass	1NT	Pass
2♦	Pass	3♣	Pass
4♥	All Pass		

3♣* = 4-card heart support, max hand, doubleton in clubs.

- A) While North is thinking about opening lead, West says to South, "Lead is yours." South leads the spade queen. North and East say West is declarer. TD!
- B) While North is thinking about opening lead, South asks who has the lead. East says, "You do." South leads the spade queen. North and East say West is declarer. TD!
- C) While North is thinking about opening lead, South asks, "Is lead with me?" West, unaware of the situation, nods in approval.



Board 7.

South/Both

South is playing 4♥. West's ♣8 played in the 5th trick (in cases a and b) is face up on the table.

- A) South won the fifth trick. South leads to the sixth trick. West wants to see the fifth trick cards. TD!
- B) East won the fifth trick. East leads to the sixth trick. West wants to see the fifth trick cards. TD!
- C) Everyone has closed their cards. South, who won the fifth trick, leads to the sixth trick. West looks at his card without showing it to the others. South calls TD.



Board 8.

West/None

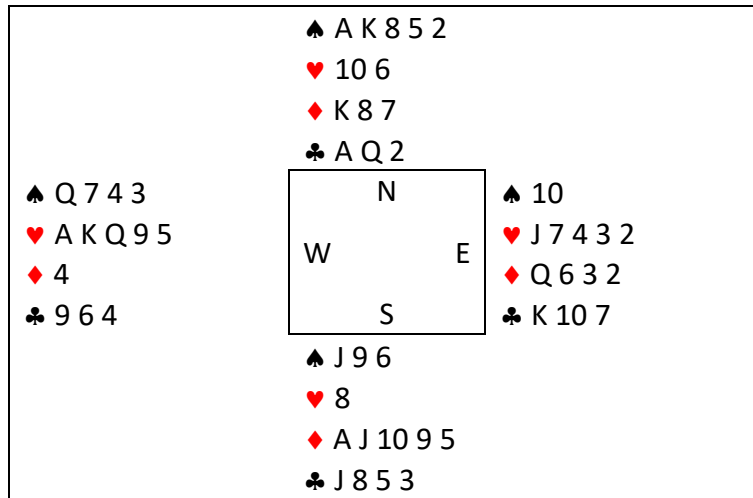

West	North	East	South
1 ♥	1 ♠	4 ♥	4 ♠
All Pass			

- A) East leads diamond two. Dummy exposed. Declarer plays the diamond king from hand. Immediately says played out of turn, wants to correct. TD!
- B) West leads the heart ace out of turn. Before other players can stop him, South puts clubs on the table. TD!
- C) West leads the heart ace out of turn. North exposes two hearts on the table. Realizes the situation, gathers cards. TD!



Simulations

Board 10.

East/Both

	♠ 7 4										
	♥ 7 6 2										
	♦ 6										
	♣ K J 10 9 8 3 2										
♠ Q J 9 8	<table style="width: 100%; text-align: center;"> <tr><td></td><td>N</td><td></td></tr> <tr><td>W</td><td></td><td>E</td></tr> <tr><td></td><td>S</td><td></td></tr> </table>		N		W		E		S		♠ K 10 6 5
	N										
W		E									
	S										
♥ 5 3			♥ A K 8 4								
♦ 10 7 5 3			♦ K Q 8 4 2								
♣ Q 6 4			♣ --								
	♠ A 3 2										
	♥ Q J 10 9										
	♦ A J 9										
	♣ A 7 5										

West	North	East	South
		1♠	1NT
2♦	2NT(!)	X	3♣
Pass	Pass	3♦	...DBL
Pass	3NT	All Pass	

It took a very long time before South bid double. East called the TD when North bid 3NT.

The TD conducted a poll with North's hand. All players felt the tempo of the double meant South was not sure whether he had enough strength to double. Three of them bid 4♣, one chose 3NT.



Board 11.

South/None

	♠ J3	
	♥ AK62	
	♦ AKJ843	
	♣ 8	
♠ AQ8642	W E	♠ 109
♥ 98		♥ J743
♦ 1075		♦ Q2
♣ 94		♣ K7653
	♠ K75	
	♥ Q105	
	♦ 96	
	♣ AQJ102	

South declares 3NT and gets the ♠2 as the first lead. He wins with the J and plays ♣8 to the Queen. West hesitates for a couple of seconds (he will say that he considered whether to give the right or wrong distribution signal in clubs). South now decides to play the ♣K in West and continues A and J in clubs. He ends 2 down and calls the TD. He suggests having a clear alternative line of play when the ♣K doesn't drop under the ace, which is trying the diamonds. Don't be too helpful, let us try the TD to decide that the play of AK in diamonds, the line south will propose, is the normal safety play. A nice question is whether playing the diamonds before the ♣A isn't superior, why can't West have a third club?



Board 13.

North/Both

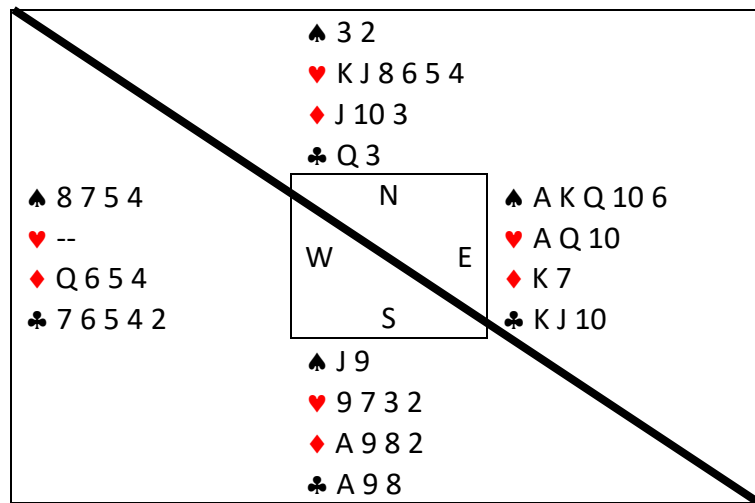

West	North	East	South
	2♦	1♣	

1♣ = Precision, 16+ any

- A) East bid 1♣, North pushed the tray.
- B) East bid 1♣, East pushed the tray.
- C) East bid 1♣. North points at East's bid and says, "OK, I accept", and pushes the tray.



Board 14.

East/None

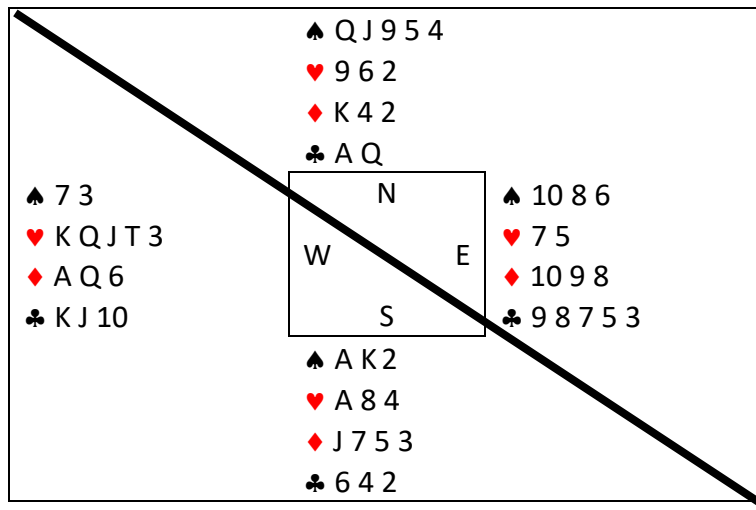

- A) North opens 1♠ OOT, East passes, before passing the tray, they realise their mistakes. TD!
- B) Now North is the dealer, East passes OOT, and North pushes the tray. TD is called from the other side of the screen.
- C) As in B, but East impatiently pushes the tray to the other side while North is busy entering some score on the bridgemate. TD is called from the other side of the screen.



Board 15.

South/NS

- A) South is playing 3NT. Takes the 2nd trick. East thinking that he took trick, leads to next trick. Declarer cannot see the card, but dummy informs declarer. TD?
- B) South is playing 3NT. West leads face down. Before South opens the screen, West says wait and retracts the opening lead. TD?
- C) South is playing 3NT. West leads face up. Before South opens the screen, West says wait and retracts the opening lead. TD?
- D) South is playing 3NT. In the fourth trick, he plays a heart from dummy, East plays heart ♥9 and ♥J to this trick. Before South can see these cards, he retracts ♥J. Dummy calls TD explaining the situation.
- E) East is playing 4♥. Takes the first trick by ruffing and leaves the card face up in front of the table. The card is not visible to South. After a 1-minute pause, East pushes the card forward again to ask for showing the closed cards. South interprets that as playing a heart to the next trick and follows the suit. Declarer calls TD.



Board 16.

West/EW

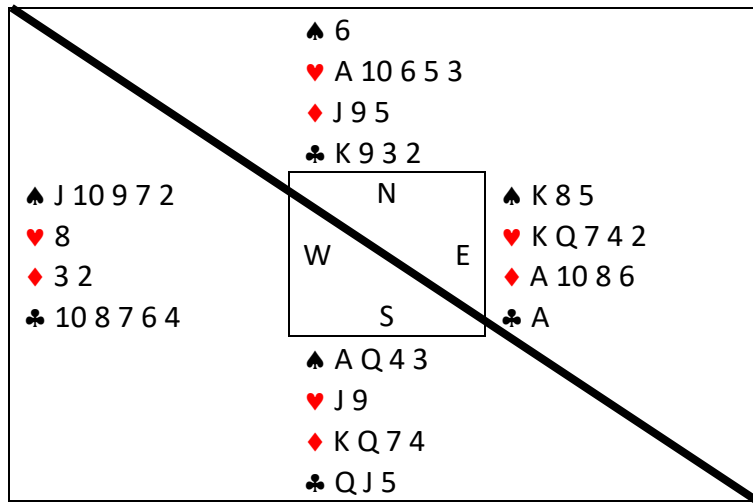

West	North	East	South
Pass	Pass	1♥	DBL
Pass	1NT	Pass	2NT
Pass	3NT	All pass	

1NT was explained 8-10

West called the TD before his final pass and reported that the tray with 1NT was very slow. He calls the TD again when the contract is made.

If TD does his investigation, he will learn (the camera) that North took 1:48 to bid 1NT and the East 0:46 to pass.



Board 17.

North/None

West	North	East	South
	1NT	Pass	3NT
Pass			

South and West thought the bidding had finished, collected 3NT, and passed, pushing the empty tray.

- A) East makes face down opening lead, North knocks on cover. West says, "Did we push the tray to you?" Situation understood. TD. (East will want to change the opening lead from club ten to heart three based on 3NT).
- B) East makes the opening lead, and dummy is exposed. North says, "Why did you pass with 12 points?" TD!
- C) East makes the opening lead. South remembers the tray wasn't pushed and calls TD. Can the opening lead change?



Board 18.

East/NS

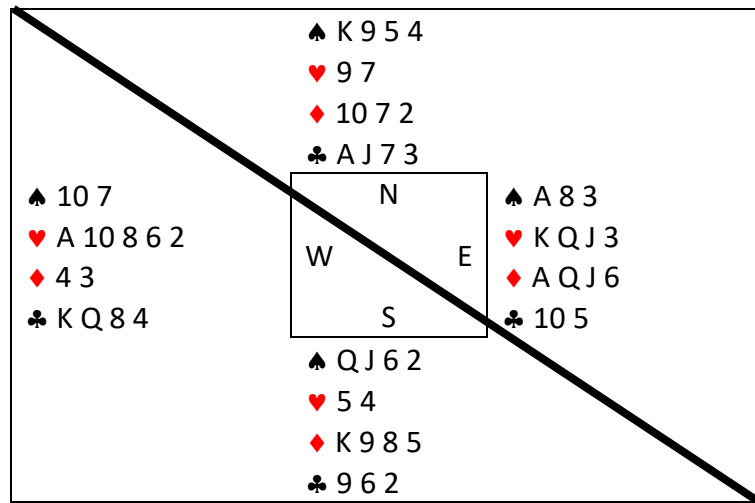

West	North	East	South
		1NT	Pass
2♦	Pass	3♣	Pass
4♥	All Pass		

3♣* = 4-card heart support, max hand, two club honours.

- A) South leads ♠Q out of turn. West opens the screen.
- B) South leads ♠Q, North leads ♦2. West opens the screen.
- C) South leads ♠Q, North leads face down (♦2). South opens the screen.



Board 19.

South/EW

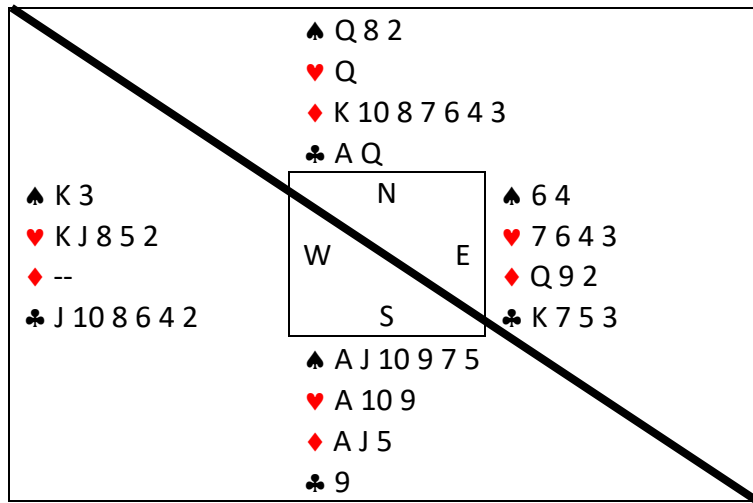

South plays 6♠.

West leads ♥5 to the Queen. Declarer loses the spade finesse to the King, and West plays ♣J to the Ace. Declarer ruffs ♣Q in hand, ruffs ♥10 in dummy and plays a spade to the Ace. West discards ♣2. Declarer plays one more spade, and both defenders discard clubs.

- A) Declarer says, "Something is wrong". West notices his revoke and replaces his first club discard with the remaining spade. Declarer draws all spades and in the 3-card ending decides to play ♦A. One down. Now he calls TD asking for a one-trick penalty.
- B) This time, West notices his revoke and asks declarer if he can correct it. Declarer nods, dummy looks annoyed but doesn't protest. Similarly to a) West replaces his revoke, declarer loses the contract and calls the TD after the board.



Board 20.

West/Both

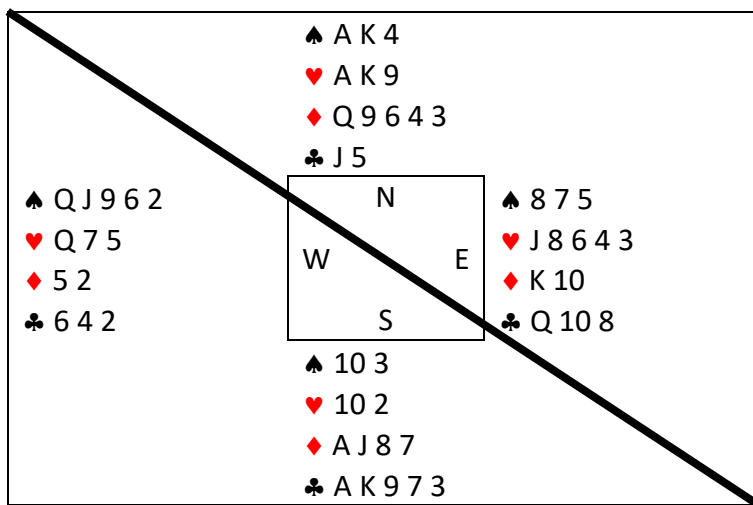

West	North	East	South
Pass	1♣	Pass	2♣
Pass	2NT	Pass	3♦
Pass	4♦	Pass	4♥
Pass	4NT	Pass	6NT
Pass	7NT	All pass	

Screens. Mixed pairs – not regular partnerships. Bidding is not important, but after some misunderstandings (playing Precision), NS ended in 7NT by North.

North is waiting for the lead, but thinks he will be dummy and

- A) shows his hand to East and asks to see her hand. They both look at each other’s hands.
- B) shows his hand to East, who says, “You’re declarer.”

TD!

In the meantime, East has led the ♥3.



Board 21.

North/NS

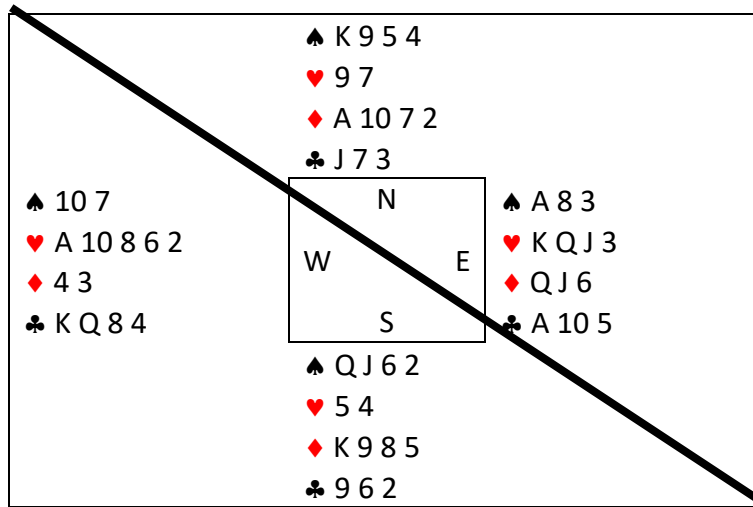

West	North	East	South
	Pass	1NT	

- A) East removes the 1NT card. Bring over the tray and touch the tray. Retracts the card without releasing it. Finally, bids 1♦. North calls the TD.
- B) East puts 1NT card on the tray. Immediately retracts 1NT. 1NT = 14-16.
- C) East opens 1♠. North pushes the tray. As soon as the tray goes to the other side, East calls TD, saying he tried to open 1NT. Meanwhile, South has passed.

**Answers**

Board 1.

- A. Simple solution. Send West away and have East explain "4441 club singleton strong hand." 3NT P P P. If TD didn't tell East to explain, South should ask TD again what to do. If told to continue, leads a spade and scores the claim.
- B. It's the director's job to determine if there's really an agreement. If asked, East says, "We agreed on bidding the suit below the singleton. West will say He thought 3♠ showed singleton club".
- C. South deliberately leading, knowing the irregularity, not trying to learn the system, showing an explanation wouldn't make a difference. Score stands.

Board 2.

- A. Law 25A, clear that 1♥ was inadvertent. Corrected without penalty, West has no right to accept or reject the change.
- B. 1♥ not inadvertent. Insufficient bid. West doesn't accept 1♥. Per Law 27B1, bidding continues from 2♥ without penalty.
- C. Law 25B. TD must be very careful to understand the situation. West may accept 1NT change if desired. If not, 1♠ stands. In both cases, a withdrawn call is unauthorised information for North.

Board 3.

- A. Law 14 deals with a player having fewer than 13 cards and nobody having more than 13. After having found the missing card, law 13A2 tells us that "the auction and play continue normally without alteration of any of the calls made, the restored hand being deemed to have contained all of its cards continuously throughout" Law 14C also tells us that "Knowledge of the replacement of a card is unauthorised for the partner of a player whose hand contained an incorrect number of cards." It's evident from North's wish to change his call that the card found made North's hand no longer a 1NT opening, and South's 2NT catered for the possibility that it was an honour. South should be penalised for using the UI. Even if the TD manages to inform North that he is not allowed to make any change before North says anything, passing 1NT as South is not only an LA, but it should be considered the only LA, and thus South bidding 2NT is a flagrant use of UI.
- B. Now we are in law 13 since one hand contained more than 13 cards. It's tempting for the TD to rule that the board is not playable because the card that moved from South to North is the Ace; however, in this case, there is nothing that prevents the board from being played yet. The TD should allow the play to continue, but when South bids 2NT, the TD should rule that the knowledge of the moved card affected the outcome of the board and award an adjusted score. Since both North and South obviously did not count their cards correctly, and at least South could have prevented the adjusted score by doing so, a penalty for South should be considered.
- C. Back to law 14. The card is found during the play, and law 14B2 and 14B4 tell us how to proceed. North has revoked, not only once but twice in the same suit, so a complete ruling should look into the possibility of a 64C correction for the second revoke, as well as the penalty trick for the first revoke.

Board 4.

- A. Law 69A, agreement not established. Law 70 applies. East takes the spade seven.
- B. Law 69 agreement established. If play had continued, playing a spade is not more likely than playing a club. Defence takes both tricks.
- C. Law 71. East wants to retract the concession. Playing a club or a spade is a normal play. Defence takes two tricks.

Board 5.

- A. Law 47E1, ♠Q retracted without penalty. The lead cannot be accepted. According to the Law 16C, unauthorised for West, authorised for North. In all examples, if TD doesn't apply a lead penalty, North will lead a small spade. EW objects, TD must say: North may use information.
- B. and C the same.



Board 6.

- A. Laws 21B3 and 47E2. South has the right to change the final pass, and North has the right to change the opening lead. TD must properly explain these rights to the player.
- B. Law 47E2. North can retract the opening lead without penalty. Since the auction has ended, the option to retract the final pass no longer exists. Law 17D.
- C. Law 47E2 - if even part of the dummy's cards are exposed, the opening lead cannot be retracted. Any damage, corrected at end of play.

Board 7.

- A. Law 66A cards are shown. West's side hasn't played the next trick. West hasn't closed the card.
- B. Law 66A cards are not shown. West's side has played to next trick.
- C. Law 66B West has the right to look at his own card without showing others until his side plays to the next trick.

Board 8.

- A. North must play diamond king when their turn comes. Law 57C3.
- B. North must accept the heart lead. Dummy exposed. North plays to second trick. Law 54C.
- C. North continues to expose his hand. South becomes declarer. Law 54A At the table, opponents explain events to the director.

Board 9.

Player conceding is East. Law 68A, East playing spade is within normal play limits. It's crucial to understand that East made the claim. East will say, "I didn't claim; I thought he had two trumps." South will say he wouldn't have claimed if not forced.

Board 10.

Score stands. The TD should ask proper questions. He will learn that the slow double suggested bidding, but didn't suggest any preference between 3NT over 4♣.

Board 11.

West's statement is doubtful, though not impossible. But the hesitation at this moment is certainly misleading: a combination of L73D1 'not particularly careful' with 73F2. There is a good reason to adjust the score. After playing ♦AK (without the ♦Q dropping, declarer most probably will make his contract. Whether he will play another diamond for 11 tricks or finesse the ♥J (which seems safer) for 9 tricks is not clear, but in a team event not really important. In pairs, continuing diamonds seems reasonable.

Board 12.

- A. There is no reason not to believe North, who is still busy making his call. Instruct East to withdraw his 1♥ bid and tell NS that the information arising from this withdrawn call is unauthorized.
- B. Law 40B2iv deals with this issue, and then the wording "prior agreement" is important. East finds this call just at this moment, which, of course, is allowed.
- C. The TD tells him that he should complete the call he started and explains that such a pass is based on unauthorised information, which is not permitted.

Board 13.

- A. The insufficient bid was accepted.
- B. The infraction was transferred to the other side of the screen, so we deal with a case as no screens are used.
- C. After drawing attention to the irregularity, North had to call the TD, but he illegally pushed the tray. The situation is not clear. The insufficient bid is not accepted and should be corrected. 1♣ is unauthorised for South. Is it unauthorised for West?

Board 14.

- A. The erroneous bidding has not been passed to the other side of the screen. The bidding should be corrected. Do not fall into the trap that East has accepted North's COOT.
- B. Screen regulations say that North has accepted the pass OOT by pushing the tray. Bidding continues without rectification.
- C. The tray was erroneously pushed by East. We have to deal with the Pass OOT according to Law 30A.



Simulations

13th EBL/WBF Max Bavin Tournament Directors Course, 27th-30th of November 2025

Board 15.

- A. Dummy may draw attention. Defender's out-of-turn lead.
- B. Cannot change the opening lead. TD must find and be convinced which card was led.
- C. Cannot change the opening lead.
- D. Dummy may draw attention. Law 58A heart 9 is played, heart jack penalty.
- E. Penalty card should not be applied. After declarer explains the situation to the TD, the declarer can also tell the TD, "I think I caused it. If you want, we can cancel the penalty."

Board 16.

The TD has to ask proper questions in the poll, presenting South's hand after 1NT: What do you bid? Do you consider any other calls? Does the slow 1NT suggest something? The outcome of the poll:

- Pass|Yes; 2NT|I think he is usually minimal and was considering 2m or 1S on a 3crd suit
- Pass|Pass|Points
- 2NT|Pass|Weakness i think
- Between pass and 2NT|pass/2N|It suggests an alternative, not necessarily a heavy 1NT (like here he considered passing)
- 2NT|Pass|Dilemma between 1NT and 2nt
- Pass|2NT|hard to say, but I will feel uncomfortable after 3 nt and 10 points for 1nt
- Pass|Pass|I think my partner has 10-11 hcp or 9-10 hcp 5 card minor.

Board 17.

- A. Bidding continues. West can change the opening lead.
- B. Bidding continues, but North and West must pass when their turn first comes to them (Law 24). East can bid, but since partner also contributed to the irregularity, unauthorised information. Opening lead card doesn't change (24).
- C. Bidding continues. West passes when the first turn comes. The visible card is unauthorised information for everyone. Opening lead card played in accordance with Law 24.

Board 18.

- A. Lead must be accepted. Dummy should be East, West plays.
- B. Correct lead ♠2 is the opening lead. ♠Q becomes a major penalty card.
- C. LOOT procedure applied.

Board 19.

- A. Split Score.
- B. Split Score, but 11 tricks is also possible.

Board 20.

- A. The hand is playable. Dummy and declarer exchange hands, and original South moves to sit North, and plays the hand. The original North is now the South and is subject to Laws 43A and 43B. Do not accept adjustments such as A-/A-, etc. It is also possible to play the board without changing South and North. In this case, North has unauthorised information about East's hand.
- B. North plays the hand. East has seen declarer's hand but is not subject to any limitations. North/South, the infringers get a top score, but TD should not adjust. (Note: It's North's lucky day: win heart lead, finesse J♦, play A♦, runs the diamonds, finesses the clubs (twice if necessary), plays the A♥ when necessary and wraps up 13 tricks).

Board 21.

- A. Per screen procedure, 1NT call not made. Continues from 1 diamond.
- B. Law 25B TD doesn't allow change. If TD asks East, will say "I remembered at the last moment it's 14-16."
- C. Law 25A TD cancels pass (doesn't show to North and East). East opens 1NT.

