



# Daily Bulletin

Editor: Brian Senior • Co-Editors: Patrick Jourdain, Micke Melander & Marek Wojcicki • Lay-out Editor: Maciek Wreczycki • Printing: Piotr Kulesza

Issue No. 2

Saturday, 13<sup>th</sup> July 2013

## Czechs on Top



Czech Republic sits proudly on top of the standings at the end of the first day, closely followed by Denmark, Italy and Germany. Defending champion, Israel started with two losses, to Finland and Bulgaria and languish in 18th place. Norway, Italy and Denmark managed a maximum 20-0 VP win apiece, while nobody scored a 10-10 draw, which requires an exact tie under the new VP scale.

Today is another two-match day, leaving the evening free to explore the local nightlife, while the Girls and Youngsters teams arrive and have their captains' meetings before starting play tomorrow morning.

### OPENING CEREMONY

A video of the opening ceremony can be found on 'newinbridge', using the following link:

<http://newinbridge.com/news/2013/jul/youth-ec-about-start>

## Schedule of Matches – Juniors Teams

### ROUND 3

Israel vs Hungary
France vs Netherlands
Ireland vs Italy
Bulgaria vs Belarus
Czech. Rep. vs Denmark
Finland vs Germany
Croatia vs Serbia
Romania vs Sweden
Norway vs Turkey
Poland vs Belgium
Austria vs England

### ROUND 4

Israel vs Czech. Rep.
Finland vs Bulgaria
Croatia vs Ireland
Romania vs France
Norway vs Hungary
Poland vs Netherlands
Austria vs Italy
England vs Belarus
Belgium vs Denmark
Turkey vs Germany
Sweden vs Serbia

Under the Patronage of:



Ministerstwo  
Sportu i Turystyki



Politechnika  
Wroclawska





Partner z mocną kartą

infrastruktura • budownictwo ogólne • energetyka i ekologia

**budimex**  
sens tworzenia

# Results

## Junior Teams

Table	Home Team	Visiting Team	Round 1			
			IMPs		VPs	
			Home Team	Visit. Team	Home Team	Visit. Team
1	ISRAEL	FINLAND	43	54	7.24	12.76
2	CROATIA	CZECH REPUBLIC	19	51	3.48	16.52
3	ROMANIA	BULGARIA	39	46	8.17	11.83
4	NORWAY	IRELAND	106	2	20.00	0.00
5	POLAND	FRANCE	38	45	8.17	11.83
6	AUSTRIA	HUNGARY	48	35	13.20	6.80
7	ENGLAND	NETHERLANDS	67	65	10.55	9.45
8	BELGIUM	ITALY	17	107	0.00	20.00
9	TURKEY	BELARUS	58	30	15.93	4.07
10	SWEDEN	DENMARK	29	46	5.99	14.01
11	SERBIA	GERMANY	21	71	1.37	18.63

## Rankings after 2 Rounds

Rank	Team	VPs
1	CZECH REPUBLIC	34.31
2	DENMARK	34.01
	ITALY	34.01
4	GERMANY	29.97
5	BULGARIA	26.94
6	NORWAY	25.99
7	POLAND	25.61
8	ROMANIA	23.62
9	FINLAND	23.31
10	TURKEY	22.95
11	HUNGARY	21.38
12	FRANCE	21.28
13	ENGLAND	19.21
14	SWEDEN	18.97
15	BELGIUM	16.08
16	NETHERLANDS	14.00
17	AUSTRIA	13.20
18	ISRAEL	12.13
19	CROATIA	8.90
20	BELARUS	6.63
21	SERBIA	5.29
22	IRELAND	2.21

## Junior Teams

Table	Home Team	Visiting Team	Round 2			
			IMPs		VPs	
			Home Team	Visit. Team	Home Team	Visit. Team
1	ISRAEL	BULGARIA	44	67	4.89	15.11
2	CZECH REPUBLIC	IRELAND	68	26	17.79	2.21
3	FINLAND	FRANCE	31	29	10.55	9.45
4	CROATIA	HUNGARY	28	48	5.42	14.58
5	ROMANIA	NETHERLANDS	69	44	15.45	4.55
6	NORWAY	ITALY	30	47	5.99	14.01
7	POLAND	BELARUS	55	16	17.44	2.56
8	AUSTRIA	DENMARK	3	120	0.00	20.00
9	ENGLAND	GERMANY	57	62	8.66	11.34
10	BELGIUM	SERBIA	78	49	16.08	3.92
11	TURKEY	SWEDEN	37	49	7.02	12.98

## Poland v France (Juniors Round 1)

by Brian Senior

Poland has won the U25 European Championships on four previous occasions, putting it level with Norway for the highest number of wins, while France has won it three times. Poland last won in 2005, while France was the champion nation in 2009 in Poiana Brasov, Romania. Of that French team, only Cedric Lorenzini is playing here in Wrocław. Half the Polish team won the Open Teams Championship at the recent Ostend Open European Championships and on that form must have good chances in Wrocław.

Poland led by 19-17 at the half-way point in the match and France levelled it up at 19-19 on the next deal. Board 12 didn't alter the score as both N/S pairs judged well to bid the diamond slam in the face of awkward opposition bidding.

Board 12. Dealer West. N/S Vul.

♠8		♠QJ97									
♥AK82		♥J965									
♦KQ1082		♦J									
♣K64		♣Q1075									
	<table style="border: 1px solid black; width: 60px; height: 60px; margin: 0 auto;"> <tr><td></td><td>N</td><td></td></tr> <tr><td>W</td><td></td><td>E</td></tr> <tr><td></td><td>S</td><td></td></tr> </table>		N		W		E		S		
	N										
W		E									
	S										
♠10543											
♥Q1043											
♦75											
♣A98											
	<table style="border: 1px solid black; width: 60px; height: 60px; margin: 0 auto;"> <tr><td></td><td>N</td><td></td></tr> <tr><td>W</td><td></td><td>E</td></tr> <tr><td></td><td>S</td><td></td></tr> </table>		N		W		E		S		
	N										
W		E									
	S										
	♠AK62										
	♥7										
	♦A9643										
	♣J32										

West	North	East	South
Coudert	Klukowski	Lorenzini	Tuczynski
2♥	3♦	3♠	4♥
Pass	4NT	Pass	5♥
Pass	6♦	All Pass	

West	North	East	South
Jassem	Bernard	Wojcieszek	Kilani
2♣	2♦	3♠	4♠
Pass	4NT	Pass	5♥
Pass	6♦	All Pass	

Both Wests opened with a bid to show a weak hand with both majors, neither promising better than four-four when non-vulnerable. For France, Julien Bernard could overcall at the two level, while Michal Klukowski, for Poland, had to come in a level higher. East could compete with 3♠, but when the respective Souths, Alexandre Kilani for France and Piotr Tuczynski for Poland, cuebid a major to show a good diamond raise, North checked on key cards and bid the slam.

With one discard coming from each hand, the slam was dependent on the club position and, with the ace onside, both declarers soon had twelve tricks for +1370 and a flat board.

Board 13. Dealer North. All Vul.

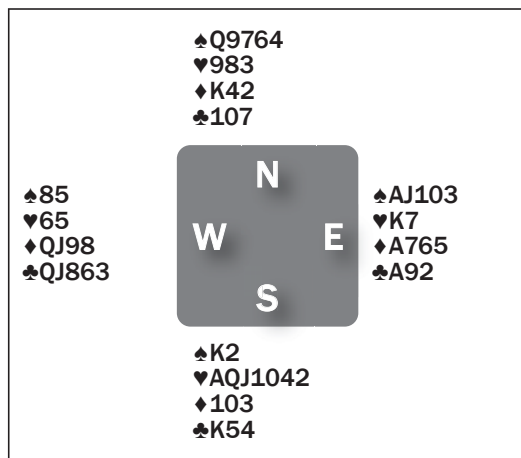

West	North	East	South
Coudert	Klukowski	Lorenzini	Tuczynski
–	Pass	1NT	2♦
Pass	2♥	Pass	Pass
Dble	Pass	2♠	Pass
3♣	3♥	All Pass	

West	North	East	South
Jassem	Bernard	Wojcieszek	Kilani
–	Pass	1NT	2♦
Pass	2♥	Pass	Pass
2NT	Pass	3♦	3♥
All Pass			

Both Souths overcalled 2♦, showing a single-suited major, and both Norths responded with a pass-or-correct 2♥. When that came round to West, both competed the partscore, Pawel



Cedric Lorenzini

Jassem with a minor-orientated 2NT, Thibault Coudert with a take-out double, converting the 2♠ response to 3♣. Both N/Ss took the push to 3♥, ending the auction.

Against Klukowski, Cedric Lorenzini kicked off with the ace of clubs, which solved all of declarer's awkward communication problems. He continued with a second club and Klukowski won the king, ruffed the third club and took the heart finesse. Though the diamond ace was offside, he had nine tricks for +140.

In the other room, Jakub Wojcieszek led the ace of spades. Bernard should have unblocked dummy's king to create an entry to hand, after which he could have played on clubs then hearts and come to nine tricks, but he played low. A second spade put him in dummy and he tried a diamond to the king and ace. Two more rounds of diamonds stuck him back in dummy and there was no way to avoid two more losers; down one for –100 and 6 IMPs to Poland, who led by 25-19.

Bernard could have recovered by playing the queen of hearts at trick three to force an entry to hand. Now he would have been able to take a diamond pitch on the spade queen, lead up to the king of clubs and ruff the third club in hand to come to nine tricks.

Board 15. Dealer South. N/S Vul.

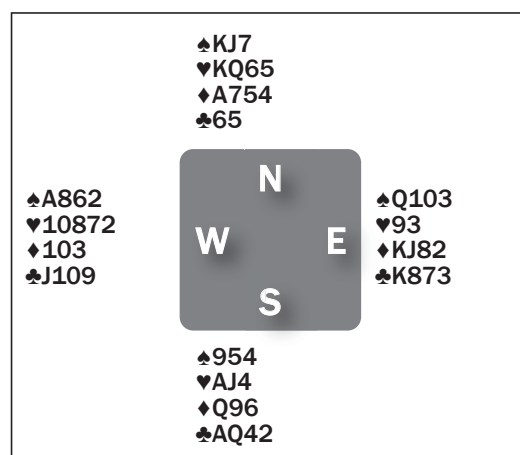

West	North	East	South
Coudert	Klukowski	Lorenzini	Tuczynski
Jassem	Bernard	Wojcieszek	Kilani
–	–	–	1♣
Pass	1♥	Pass	1NT
Pass	3NT	All Pass	

Two simple auctions led to a normal game contract, against which both Wests led a low spade, run to East’s ten.

Wojcieszek switched to the two of diamonds to the ten and ace and Kilani played a diamond back to the jack and queen then a third round. Wojcieszek won the king and cashed the eight then switched to a low club. Kilani put in the queen and led a spade to dummy’s king and had nine tricks for +600.

Lorenzini switched to the eight of clubs. Tuczynski put in the queen and Coudert dropped the jack. Now Tuczynski cashed four rounds of hearts and Lorenzini was squeezed. Thanks to the helpful play of the jack of clubs, he knew he could afford to unguard that suit so pitched the king then seven. Tuczynski threw a spade from hand and now led a low diamond towards his queen. Lorenzini went in with the king and returned his remaining club and declarer ducked to Coudert’s nine. Though it seemed that Tuczynski had played the hand very well, he was still down to the spade guess, as Coudert now underled his ace for a second time. When he got the spade wrong, he was down two for –200 and 13 IMPs to France, who had the lead at 33–25.

Board 17. Dealer North. None Vul.

♠AKQJ			
♥9			
♦A4			
♣1098543			
	N		
♠–	W	E	♠9652
♥Q1087			♥643
♦K86532			♦QJ107
♣KJ2			♣A6
	S		
			♠108743
			♥AKJ52
			♦9
			♣Q7

West	North	East	South
Coudert	Klukowski	Lorenzini	Tuczynski
–	1♣	Pass	1♠
3♦	4♦	5♦	5♥
Pass	5♠	All Pass	

West	North	East	South
Jassem	Bernard	Wojcieszek	Kilani
–	1♣	Pass	1♠
2♦	3♠	4♦	4NT
Pass	5♦	Pass	6♣
All Pass			

Klukowski opened a Polish Club and Tuczynski made a natural positive 1♠ response. When Coudert now made a



Piotr Tuczynski

weak jump overcall, Klukowski cuebid to show a strong spade raise and Lorenzini saved in 5♦. Tuczynski made a slam try but Klukowski had already done plenty of bidding, given the weakness of his side suit, so signed off in 5♠, ending the auction.

Tuczynski won the diamond lead with dummy’s bare ace and conceded a club. He ruffed the diamond return in hand and conceded a second club. Nothing could prevent his making the remainder of the tricks for +450.

Bernard opened a natural 1♣ and Jassem made only a simple overcall after Kilani’s 1♠ response. Bernard raised only to 3♠ but that was sufficient for Kilani to ask for key cards over Wojcieszek’s diamond raise, and Kilani next bid the slam, no doubt imagining that queen-doubleton club was a good holding in his partner’s suit. Alas, it was not, and with no realistic hope of making his contract even after a heart lead round to his tenace, Kilani managed to go down three for –150 and 12 IMPs to Poland, who were back in front at 37–33.



Michal Klukowski

Board 18. Dealer East. N/S Vul.

	♠8543 ♥K ♦108753 ♣983										
♠KQJ2 ♥AJ1093 ♦6 ♣A52	<table border="1"> <tr><td></td><td>N</td><td></td></tr> <tr><td>W</td><td></td><td>E</td></tr> <tr><td></td><td>S</td><td></td></tr> </table>		N		W		E		S		♠A108 ♥Q876542 ♦Q2 ♣J
	N										
W		E									
	S										
	♠97 ♥— ♦AKJ94 ♣KQ10764										



Thibault Coudert

West	North	East	South
Coudert	Klukowski	Lorenzini	Tuczynski
—	—	Pass	1♦
1♥	Pass	4♥	All Pass

West	North	East	South
Jassem	Bernard	Wojcieszek	Kilani
—	—	3♥	4NT
5♥	All Pass		

West	North	East	South
Coudert	Klukowski	Lorenzini	Tuczynski
Pass	1♣	1♦	1♠
Pass	2NT	Pass	3NT
All Pass			

West	North	East	South
Jassem	Bernard	Wojcieszek	Kilani
Pass	1♣	Pass	2♣
Pass	2♠	Pass	2NT
Pass	4NT	Pass	5♥
Pass	6♣	All Pass	

Six Hearts is completely cold on the E/W cards but is it biddable? Where Wojcieszek opened with a 3♥ pre-empt, Kilani overcalled 4NT, minors, and Jassem ended the auction with 5♥. At a different vulnerability, 6♦ might have been a good save for N/S, but Bernard was not tempted when vulnerable against not.

Lorenzini was not prepared to pre-empt on such a poor suit and with some potential for a spade contract so Tuczynski got to open 1♦. When Coudert, no doubt somewhat to his partner's surprise, could overcall 1♥. Lorenzini jumped straight to 4♥, fearing that any more subtle approach might permit his opponents to get together and find a contract in a minor suit. Four Hearts ended the auction.

Both declarers lost a diamond trick so the board was flat at +480.

Klukowski opened a Polish Club then jumped to 2NT to show his strength and hand-type. Tuczynski had no reason to do more than simple raise to 3NT, and after a diamond lead the fall of the queen of clubs meant that there were twelve tricks for +690.

Kilani made an inverted club raise and followed through by showing a balanced hand, over which Bernard's jump to 4NT looks quantitative. Kilani responded to key card, perhaps because he was accepting the invitation anyway, and Bernard signed off in 6♣. This would have been a tough play problem for Bernard on a passive lead, but Wojcieszek led a diamond and Bernard ran it to his hand and had twelve tricks for +1370.

Those slightly fortuitous 12 IMPs gave France a win in the match by 45-38 IMPs, 11.83-8.17 VPs.

Board 20. Dealer West. All Vul.

	♠AKQ3 ♥J96 ♦Q106 ♣AK10										
♠9642 ♥K1073 ♦3 ♣8765	<table border="1"> <tr><td></td><td>N</td><td></td></tr> <tr><td>W</td><td></td><td>E</td></tr> <tr><td></td><td>S</td><td></td></tr> </table>		N		W		E		S		♠875 ♥Q54 ♦KJ9854 ♣Q
	N										
W		E									
	S										
	♠J10 ♥A82 ♦A72 ♣J9432										

**NEW MOBILE DEVICE POLICY**

Please take note that we are using a new policy for mobile phones at these championships. It is allowed to bring your mobile phones to the table provided they are completely switched off at all times. When going to the restrooms, however, they must be left at the table or with the person escorting you to the restrooms. Any breach of these rules (such as a phone ringing or vibrating) will be penalized in accordance with the General Conditions of Contest. Such penalties are automatic and compulsory for the first offense.

# My Music

by Micke Melander

When asked about putting down the top eight songs of my choice I simply agreed about it. But when I started to study the problem I realized that this was going to be a serious problem. Twenty or thirty masterpieces would have been by far easier. When you are wide in what you prefer listening to the mood you are in is going to reflect what you in fact are going to enjoy. But I would in general put myself in the rock, hard rock, pop section of the record store when searching for something that I like.

I can't say I'm happy to leave out Zappa, Hendrix, BTO, CCD, Deep Purple, Rolling Stones, Metallica, Judas Priest and many other...

The big eight:

## 1. The bell – Mike Oldfield

A real masterpiece, how someone can put together something that is so brilliant is simply unbelievable. Mike Oldfield have since 1973 released many versions of his Tubular Bells and for those who haven't had the occasion to listen to it – you are in for a treat. He is also kind of unique since he on many records plays most of the instruments by himself and when holding a concert he instead use large symphony orchestras to be able to present it!

Check: [http://www.youtube.com/watch?v=lgQpu\\_Ciyug&feature=related](http://www.youtube.com/watch?v=lgQpu_Ciyug&feature=related)

## 2. Bohemian rhapsody – Queen

It would be easy to put down eight songs on this list only by Queen. It's sad that the music world lost Freddie Mercury too early in 1991 after he had fought aids for many years. One might wonder how it felt to play in a group like Queen knowing that it all would end in a relatively short time and starting producing songs like "The Show must go on", "These are the days of our lives" and many more as statements. Just "These are the days of our lives" and "Bohemian rhapsody" are unique songs since they both had been on the top of the charts in many countries around the globe, been knocked out after a while and then come back again to the top after the death of Freddie Mercury when the two songs were re-released on a single on the memory of him.

## 3. Let there be love – Simple Minds

A Scottish band with a lot of political messages hidden in their lyrics. "Mandela day" and "Belfast Child" are two examples. I never forget when I saw them playing live in Stockholm when they opened the concert with Waterfront in a pitch dark arena and used a laser to produce a waterfall on the edge of the stage. Simply Magic, playing with the Minds!

## 4. The boys are back in town – Thin Lizzy

Another giant on the stage that passed away too early, Phil Lynnot only became 36 years old and the drug usage led to his death in 1986. "Jailbreak", "Whiskey in the jar" or "The boys are back in town" could all be picked. Gary Moore who has to be ranked as one of the world's greatest guitar players was one of the bricks in the famous Thin Lizzy group.

## 5. Hells Bells – AC/DC

It would be completely impossible to set a list of eight songs without having the most known Australian group somewhere on it. The first record I ever bought for my own savings was "If you want blood" by AC/DC which was released in 1978 – I was then 11... I think I have bought 15 more albums after that – just wish I will be able to see them live before they quit playing. But I bet the odds are good for it I believe they probably will continue to 2015 so they can celebrate 40 years as a band!

## 6. I still haven't found what I'm looking for – U2

Another group where we can put up a long list of songs which easily could fit in the top 8 on my chart. "The Joshua Tree" from 1987 has to be considered as one of the best albums ever produced. But I can't say I really like the material they produced after "Rattle and Hum" in 1988. Their influence and trying's to make the world a better place is impressive. Bono was named person of the year in 2005 and has been proposed to get the Nobel Peace Prize at three occasions!

## 7. Pour some sugar on me – Def Leppard

The only band I have seen live more than five times. The first concert I saw with them was in 1981 when they had released their first album "On through the night". It was with tears in my eyes I received the message that Rick Allen the drummer had lost his left arm in a car accident in 1984. Rick however come back and three years later he was back with a special set of drums where he played everything he was supposed to do with his left arm with his foot instead! Amazing.

## 8. Holy Diver – Dio

Ronnie James Dio was a giant of the hard rock scene after being a band member of giants as Rainbow and Black Sabbath. He passed away in 2010 when the doctors weren't able to treat the stomach cancer they discovered in 2009.

Enjoy!

# Netherlands v. England (Juniors Round 1)

by Patrick Jourdain

The Netherlands have much the same team here as won the World Junior Team title last year so they must be considered a podium prospect. In their first match they faced an England team with plenty of experience at international level so it promised to be a good contest.

As it happened the first six boards provided ample copy for a journalist:

England captain David Gold placed Basil Letts & Shivam Shah North/South in the Open Room against Ernst Wackwitz & Chris Westerbeek for the world champions. At the other table Dutch journalist Kees Tammens was reporting the action between Tom Paske & Graeme Robertson against Jamilla Spangenberg & Joris van Lankveld.

Board 1. Dealer North. None Vul.

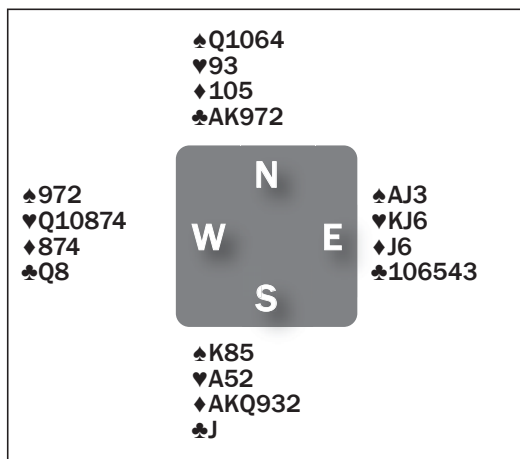

West	North	East	South
Wackwitz	Letts	Westerbeek	Shah
–	Pass	1NT	Dble
Rdbl	Pass	2♣	Dble
2♥	Dble	Pass	3♦
Pass	3♥	Dble	3NT
All Pass			

Westerbeek who, somewhat confusingly, sits East, opened a mini-notrump (10-12). Shah doubled for penalties and Wackwitz redoubled to show a one-suited rescue. Openere removed compulsorily to 2♣, south made a further take-out double, West revealed his actual suit, and it was the turn of Letts to make a take-out double. His next call of Three Hearts asked for a stop and Westerbeek took his chance to double for the lead. Shah duly bid 3NT in an auction that was probably unopposed at most tables.

A heart lead to the king held and the jack of hearts was also ducked. Wackwitz showed some class by overtaking and switching to a club, choosing the eight. This gave Shah some temporary inconvenience in entries but, realising the club winner in dummy would come to life later, he took the

ace and ran his diamonds. In the ending declarer was down to three spades and the ace of hearts, dummy held three spades and the winning club. When East decided to throw his heart Shah simply played a spade to the queen and had a risk-nothing endplay for the overtrick. 10 tricks proved to be worth the 1 IMP for the overtrick with the Closed Room recording 3NT just made.

Board 2. Dealer East. N/S Vul.

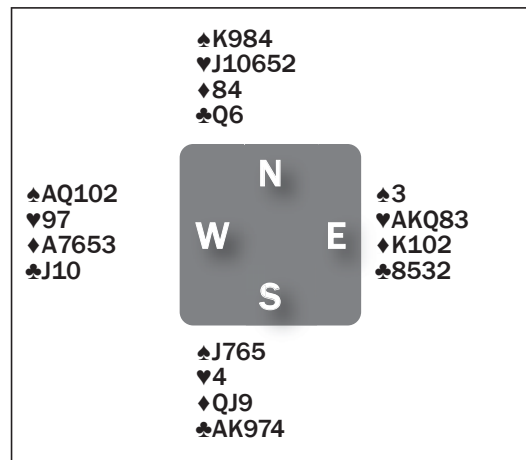

West	North	East	South
Wackwitz	Letts	Westerbeek	Shah
–	–	1♥	Dble
Rdbl	1♠	2♣	Pass
2NT	Pass	3NT	All Pass

This auction had a most unusual start in this sense: South's take-out double of 1♥ often has spades, West's redouble promised at least four spades, and North's 1♠ also showed the suit. When did you last hear an auction in which the same suit has been shown three times at the one level! It must have been no surprise to Westerbeek that he was looking at a singleton spade. His club suit may look emaciated but the eight proves a relevant card in notrumps as it prevents the defence running their clubs.

Wackwitz ended in a thin 3NT and received a diamond lead from North. He put in the ten and allowed Shah to hold the jack. Shah switched to the seven of spades. There was a risk that if declarer put in the ten and that lost North might find a fatal club switch, so it was right for Wackwitz to try the queen first. That indeed lost but North switched back to diamonds. Now it looks as if declarer is home for he can test the hearts and, when they fail to break, use a second spade finesse for his ninth trick.

Wackwitz won the diamond king and ran three hearts but he clearly thought he would have another chance later if he followed by running diamonds. Shah had other ideas. On the last diamond he ditched the ace of clubs, retaining the nine as an exit card to reach North's heart winners. Wackwitz had to



resign himself to one down. Well defended by Shah, and worth a 4 IMP gain when a simple 2♥ came home at the other table.

Board 3. Dealer South. E/W Vul.

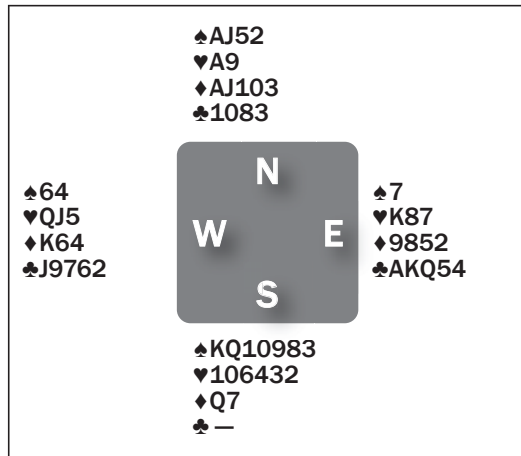

West	North	East	South
Wackwitz	Letts	Westerbeek	Shah
—	—	—	Pass
Pass	1♣	Pass	1♥
Pass	2♠	Pass	4♠
All Pass			

1♣ was prepared, the response of 1♥ showed spades, the jump to 2♠ showed four cards, usually in a weak notrump hand, and South simply raised to game.

Slam is basically on the diamond finesse so it was reasonable to stop in game. 12 tricks proved easy which was of especial significance at the other table where the same game was doubled. That was worth 7 IMPs to the Netherlands.

Board 4. Dealer West. Both Vul.

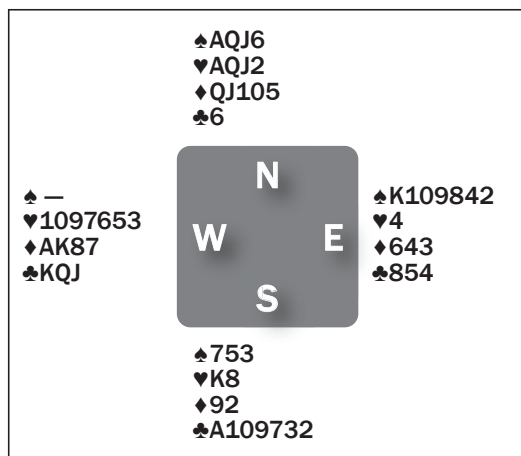

West	North	East	South
Wackwitz	Letts	Westerbeek	Shah
1♥	1♠	Pass	2♠
Pass	3NT	Pass	4♠
Pass	Pass	Dble	All Pass

Over the opening 1♥ Letts had the option of calling 1NT despite the singleton club, overcalling on a four-card suit, or a ‘awaiting developments’ Pass (there would be none).

It looked as if South would pass 3NT, as he surely should with bad spades and the heart king as extra protection, but it was a particularly bad moment to go back to spades. East may have been checking the backs of his cards to see if he had the wrong hand but unkindly doubled.

North might have taken the cue to run to 4NT which would have been less painful but eventually stuck it out. The contract went three light for 800 to the Netherlands.

Strange to tell the N/S at the other table also got in a mess, ending in four Clubs doubled for –500 so the swing to the Netherlands was cut to 7 IMPs.

3NT is clearly the best game for N/S and proves a fascinating contract. It looks as if declarer has nine tricks with four hearts, two diamonds, two spades and a club but I think the defence can always come to two diamonds, two clubs and a spade first. Suppose East leads a heart and West wins the first diamond to play a second heart. Now the clubs are no longer a threat so West can use his second diamond winner to attack clubs ensuring the defence has five tricks when declarer tries to set up his spade. If declarer tries the spades earlier then East must switch to clubs.

Board 5. Dealer North. N/S Vul.

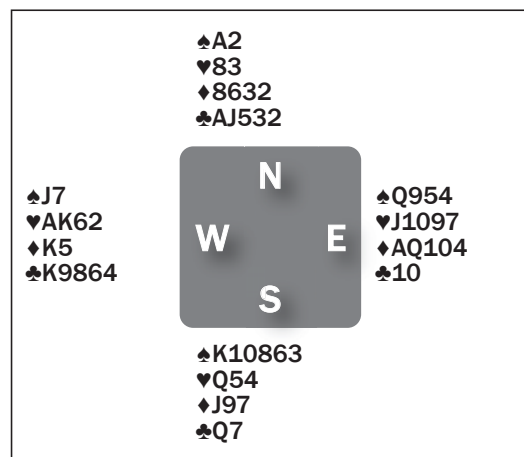

West	North	East	South
Wackwitz	Letts	Westerbeek	Shah
—	Pass	Pass	Pass
1NT	Pass	2♣	Pass
2♥	Pass	4♥	All Pass

At last a standard auction though West’s 14-16 notrump was a non-standard shape. Four Hearts has chances whatever the lead but its chances appeared to have improved when North led a diamond.

Wackwitz made the right decision to play low from dummy but perhaps a little too hastily played three rounds of the suit to ditch a spade loser. For example it may pay to lay down one top trump first.

When the diamond jack put in an appearance things had improved again, but declarer wanted to lead a club from the table: ten, queen, king, ace. North knew his partner must have the spade king so he followed with ace and another. Declarer ruffed the second spade and ruffed a club.

Declarer obviously can make if he guesses the layout of hearts and clubs but the play continued with the winning ten



Ernst Wackwitz



Chris Westerbeek

of diamonds ruffed low by South and over-ruffed by West's six. Next came a third club ruffed, and this time it was south over-ruffing. Shah returned a trump.

West was on play with a known ruffing finesse in clubs and a master trump in each hand. But Letts made no mistake. He covered the first club with the jack forcing declarer to ruff at trick 11. The only route back to hand was a spade ruff and North could ditch his small club and triumphantly claim his eight of trumps as the setting trick at the end.

At the other table according to the record West reached Three diamonds making, so the swing was only 4 IMPs to England.

Board 6. Dealer East. E/W Vul.

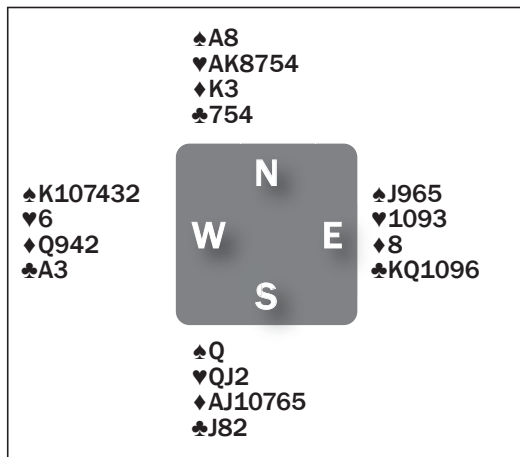

West	North	East	South
Wackwitz	Letts	Westerbeek	Shah
–	–	Pass	1♦
1♠	2♥	3♠	Pass
4♠	Dble	Pass	5♥
Pass	Pass	5♠	Pass
Pass	Dble	All Pass	

Here East/West can make Four Spades on very minimal values. East's raise was pre-emptive in nature but, at adverse

vulnerable, must have sound values, so Wackwitz made the excellent decision to go on to game.

Letts could only double this to show he had spare values and Shah, with a minimum opening but undisclosed support for partner, rightly took the save. Indeed Five Hearts might succeed on a spade lead so maybe East, though superficially wrong, might have in practice saved his side a worse board when he defied the advice that “the Five level belongs to the opponents”.

Five Spades doubled duly went one off for 200 to England.

At the other table N/S were allowed to play in Five Diamonds for three down undoubled. The swing was 8 IMPs to England.

East faced a close play problem on the next deal in 3NT. The defence knocked out his only diamond stop and he had to play this combination:



You have the choice of testing spades and then relying on clubs or testing clubs and then relying on spades. This was the auction:

West	North	East	South
Wackwitz	Letts	Westerbeek	Shah
–	–	–	Pass
1♣	1♥	Dble	Pass
2♥	Pass	2NT	Pass
3♣	Pass	3NT	All Pass

You now wish you had selected Four Spades rather than 3NT when South leads the three of diamonds playing fourth highest. You win the second diamond and deduce North has nine red cards.

Without this information you would probably test the clubs from the top down and if they did not behave rely on

spades. However the odds are now different. We can have sympathy with declarer for deciding to cash the top spades and then make a bold finesse of the club ten.

Cruelly this lost to J9 doubleton and the game was three light. This was worth 14 IMPs to England when they made 11 tricks in spades at the other table.

The Netherlands recovered well from this setback and the final result was a narrow win to England 67-65 in IMPs. This translated on the new interminable scale (hated by journalists who cannot any longer report a true score) to 10.55-9.45.

### HELP!

There is a law of nature which states that, whenever something truly newsworthy takes place, all the bulletin staff will be watching at a different table. So please, help us to make these bulletins the best they can be. If you, your partner, or an opponent, does something clever, or maybe something ridiculously bad that would make a good story, let us know.

You can call into the bulletin office on the balcony overlooking the playing area, or email the story to:

bsenior@hotmail.com

## Daily Play Problem 2

Dealer East. N/S Vul.

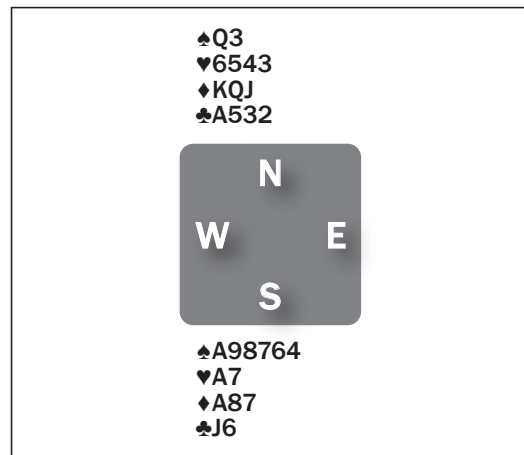

West	North	East	South
–	–	1NT	2♠
Pass	4♠	All Pass	

North had no good choice, but queen-second as trump support will often work when partner overcalls over 1NT (15-17) being vulnerable, and he raised to game. How do you plan your play when West leads the ten of hearts and East covers it with the jack, any ideas?

## Meet the Swedish Delegation

Swedes love television and we all have our favourite TV-series character. Here, however, it's not about who you like – it's about who you are!

### Junior Team

Being goodhearted and friendly as few are, **Simon Ekenberg** (21) reminds us of Earl Hickey (My Name is Earl). We're pretty sure he could grow a good 'stache and he for sure would have the time to travel all over the country so despite having good karma from birth and not serving any jailtime (at least that we know of) the two could be long lost twins.

Joey Tribbiani (Friends) is known for his fondness of meat. Since **Simon Hult** (18) can easily pounce down a 800 gram steak together with the fact that he's also very caring, nice and has doubtful acting skills makes further comparisons unnecessary.

Outside the bridge world **Cecilia Rimstedt** (25) lives a quiet life studying, far from the spotlights. Once 'on stage' however, she's a superstar. This double life of sorts is just

like Hannah Montana's (Hannah Montana) and, like her TV-counterpart, she loves to sing. We can't wait to hear her from the top of the podium next Sunday!

Apart from being blonde, **Ida Grönkvist** (18) shares a lot of similarities with Lois Lane (Smallville). Ida is sophisticated, smart and is dreaming of being a journalist just like ms. Lane. Her love interest, on the other hand, has nothing in common with Clark Kent/Superman.

**Johan Karlsson** (23) is *literally* Robin Scherbatsky (How I Met Your Mother) even though he's not planning on becoming a world famous journalist. They were both born in the woods in the middle of nowhere, are big fans of nature life, and love a good scotch now and then. His career as a teenage popstar, however, wasn't much of a success

Being a physicist (or at least currently trying to become one) **Daniel Gullberg** (21) has a lot in common with Dr. Sheldon Cooper (The Big Bang Theory). He has a nerdy hobby that he spends a lot of time with, be it bridge instead of Star Trek, and is known for his swift and sharp tongue just like the



Swedish JSG teams Wrocław 2013

good doctor. They also seem to share a mutual liking of correcting their friends whenever they utter something not supported by facts.

### Youngsters Team

**Ola Rimstedt** (17) is handsome, considerate and naturally a love interest amongst the girls. Although excusing himself with bridge, we are all quite certain he is really on the hunt for the one. So, for you girls playing who normally are without a partner: your Mr. Big (Sex and the City) might be right here in Wrocław, waiting for you.

He might look sweet and innocent, but just like Stewie Griffin (Family Guy) **Johan Säfsten** (17) has plans of taking over the world, starting with winning this championship. His sophisticated ways might not be as extremely shocking for his age as his TV-counterpart's, but they are still considerable.

"I wanna be the very best..." sings **Mikael Grönkvist** (20) as he once again attempts to win an international title with a new team. Just like Ash Ketchum (Pokémon) he's very stubborn and it feels like he's been around since forever. Despite that he's somehow still in the youngsters team?!

Just like Kenny McCormick (South Park) **Mikael Rimstedt** (17) has once again risen from the dead and is back for another championship. If the weather allows it he's certain to walk around Wrocław in one of his beloved hoodies but since he's not from the Netherlands it will be of the 'wrong' colour.

**Adam Stokka** (20) is known as the Swedish delegation's bad boy with his good looks and mischievous smile. Coming from the deep forests of the North we're also pretty sure he would do as well as on a deserted island as James 'Sawyer' Ford (Lost).

### Girls Team

**Klara Asplund** (19) shares a lot of Lisa Simpson's (The Simpsons) characteristics (but not her hairstyle). She's both smart, caring and easily likeable. You can probably imagine our disappointment when we learned that she doesn't play the sax.

With a sleep cycle that involves staying up all night as well as a distaste of sunlight, **Erika Rodin** (21) was probably a vampire in an earlier life. Damon Salvatore (The Vampire Diaries) also shares some other traits of hers, for example the frequent use of sarcasm, good looks and being somewhat precocious.

**Moa Petersen** (21) and **Irma Petersen** (17) could easily portrait Lynette Scavo and Susan Mayer (Desperate Housewives) since they are both in long and serious relationships with guys already working full time. Somehow they also always seem to have heard the latest rumours and gossip, how do they do it?

### NPC:s

Jack Bauer ("24") doesn't negotiate with terrorists. **Per Leandersson** (Captain, 33) doesn't negotiate with us juniors. Always working towards a (too) close deadline he does his best to protect the countries interests and is the one that ends up having to put his ass on the line when someone has screwed up.

The opinions concerning the man and the myth **PO Sundelin** (Coach, Old) are divided, but one thing is for sure: When you hear him approach in the corridor, you shut up. Much like Dr. Gregory House (House) with his magnetizing cane, people realize that despite his sarcasm and sometimes bitter tone he is worth listening to. [insert joke about old folks and pills of your choice]

# The 6<sup>th</sup> Open European Championships – Ostend 2013

by Brian Senior

Many of the best-played hands during the championships featured squeezes. Here is a selection of the best.

Board 1. Dealer North. None Vul.

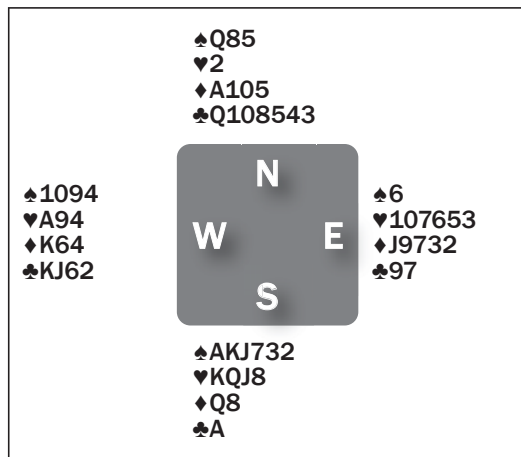

During a Mixed Teams match both Souths found themselves in 6♣ on a low trump lead. How would you play?

Israel's Ron Pachtman won dummy's queen to lead a heart to the king and ace. Back came a second trump. He won, cashed the ace of clubs and ruffed his low heart. A club ruff was followed by all the major-suit winners and West was positionally squeezed between the king of clubs and his diamond holding to see the contract home.

At the other table, Bulgaria's Steliana Ivanova won the opening lead in hand and cashed the ace of clubs. She then played the jack of hearts from hand and West took the ace to play a second trump. Ivanova won with dummy's queen, ruffed a club, ruffed a heart and took a second club ruff. When the king did not fall, she too cashed all her major-suit winners and, once again, West was squeezed between his two minor-suit holdings so the contract made for a flat board.

Which line of play do you prefer? I would vote for Ivanova's, which gives a much better chance of establishing the clubs, thereby improving the chance of avoiding the need for the rather fortunate squeeze ending to materialise. Pachtman's line seems to gain only when East has a short heart holding including the ace so that ducking does not help

## SYSTEMS

The systems being played here in Wrocław can be found via the link on the EBL Home page, or by using the link below:

<http://www.ecatsbridge.com/documents/docdefault.asp?page=EBLYBC13>

him or errs by going up with the ace from length so that declarer has two diamond discards on the hearts and ruffs the diamond queen in the dummy for his twelfth trick.

Board 4. Dealer West. All Vul.

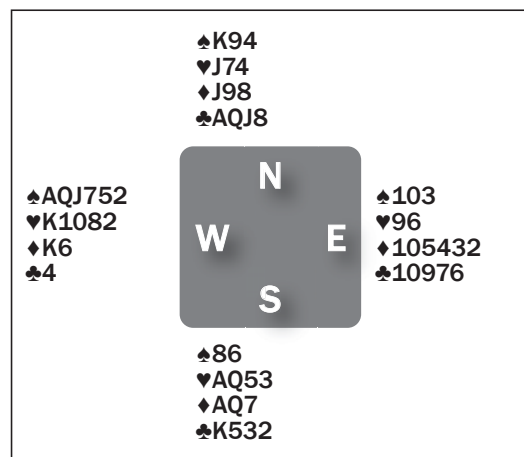

West	North	East	South
Smederevac	Prokhorov	Wernle	Klidzeja
1♥	Pass	Pass	1NT
2♠	2NT	Pass	3♣
Pass	3NT	All Pass	

This deal came up during the Mixed Pairs qualifying stage. The Austrian E/W pair were playing Blue Club, which frequently involves the use of canapé, bidding the second longest suit first. North's 2NT was Lebensohl, his sequence promising a spade stopper but fewer than four hearts.

Jovanka Smederevac led the ace then queen of spades. Latvia's Edite Klidzeja won the king and cashed the king and ace of clubs before exiting with dummy's third spade. West could cash her spade tricks to reach this end position:

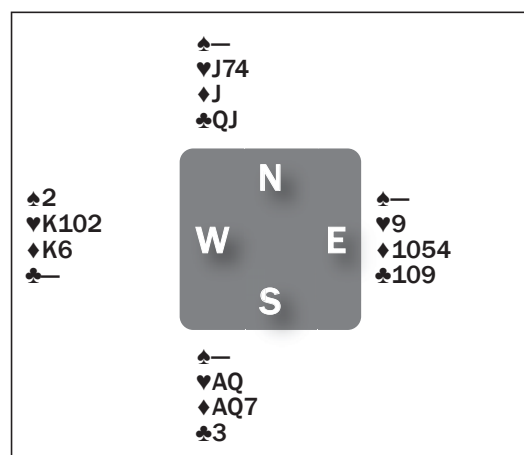

Next came the last spade, dummy discarding a heart, East a diamond and declarer the queen of hearts. Smederevac now had a safe heart exit to the bare king, only to find herself squeezed a few seconds later. Klidzeja won the ace of hearts and cashed the two club winners, throwing a diamond from hand. West could not keep guards for both her red kings so the contract was only one down.

One down only scored 40% for N/S, but down two would have been worth only 10%. When a good result is not possible, it pays to try to achieve the least bad result possible.

Board 30. Dealer East. None Vul.

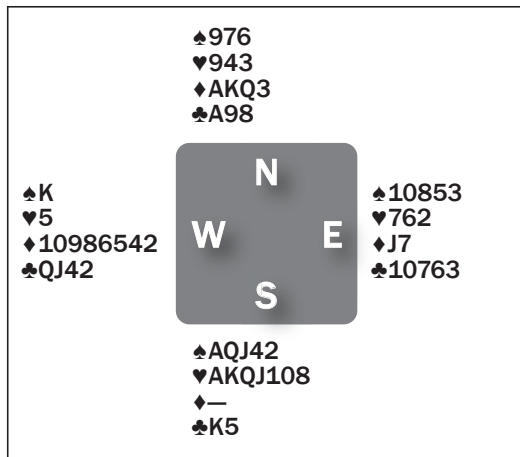

Geir Helgemo was one of many to declare 7NT from the South hand, though a good many failed to find the winning play. West led the ten of diamonds to dummy's ace, Helgemo throwing a spade. He had 12 top tricks and the spade finesse was one option for the thirteenth. However, perhaps there was a squeeze to avoid the need to rely on the finesse?

Helgemo cashed the other top diamonds, pitching two more spades from hand, and gained some interesting information when East also threw a spade on the third round. Next came all the heart winners. Prior to the sixth heart, East had thrown three spades and West three diamonds and a club. If the spades had started out life dividing four-one, there would be a straightforward double squeeze, with neither defender able to keep a club stopper in the ending. However, if spades were five-zero, declarer would have to read the end position correctly to see his contract home.

In practice, West solved all the problems as he discarded the king of spades, thinking that he was the sole possessor of a club guard, so Helgemo could claim.

Helgemo would surely have succeeded even without the fatal spade discard. West was most unlikely to have stayed silent throughout with seven-five in the minors, so rated not to be void in spades. Also, if he throws a club on the last heart, away goes dummy's diamond and now declarer cashes the top clubs. When West follows with the jack and queen, it will look very much as though he has given up a sure club guard, so must surely be keeping something important in spades – if West has concealed the ten of clubs, East has done very well not to discard from his own three low clubs – so a spade to the ace, dropping the king, looks to be the indicated play.

Board 20. Dealer West. All Vul.

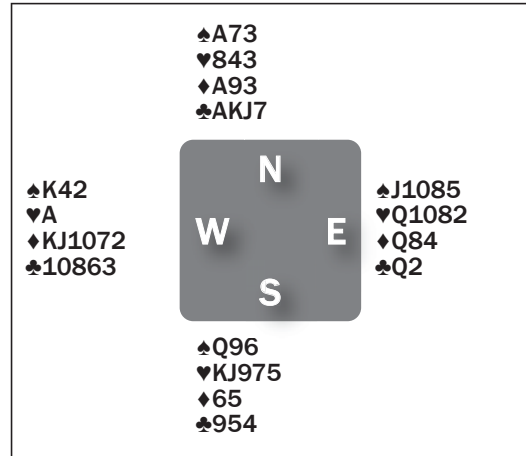

West	North	East	South
Brogeland	Lev	Brogeland	Levitina
1♦	Dble	Pass	1♥
Pass	Pass	Dble	2♥
All Pass			

USA's Irina Levitina is one of that rare breed, a former world chess champion and more recently a world bridge champion. Here she partnered Sam Lev against Norway's Boye and Tonje Brogeland in the Mixed Pairs final. How many tricks would you expect to make as declarer in 2♥? You would do well to match Levitina's eleven!

West led a low club to dummy's ace and Levitina led a heart to the nine and ace. West returned the eight of clubs, hoping to mislead declarer regarding the position of the queen. The eight proved to be an expensive card as Levitina called for the king and was pleased to see the queen put in an appearance on her right. She unblocked the nine and next ran the eight of hearts. When that held the trick, she repeated the heart finesse, drew the last trump, and led her low club to the jack, West having pitched a club on the hearts. This was the position when declarer next cashed the seven of clubs:

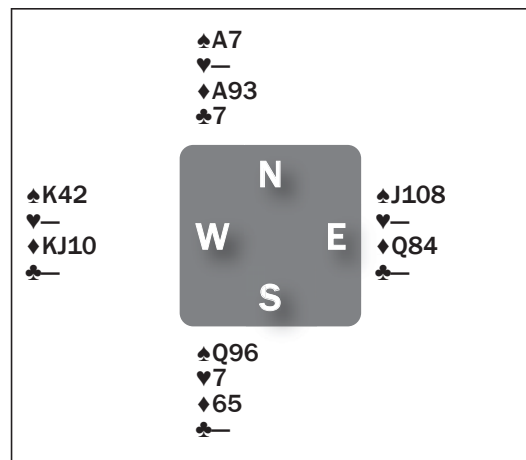

East could not afford a spade as ace and another would then have established declarer's nine, so he threw a diamond, as did declarer. But now West could not afford a diamond pitch as ace and another would see declarer ruff to establish an extra diamond trick. So West threw a spade, only for Levitina to play ace of spades then duck a spade to the now bare king,

and the spade queen became the eleventh trick, for +200 and an 82% board. That, we are assured by the Daily Bulletin, is a double ruffing squeeze – and very elegant it looks.

Board 17. Dealer North. None Vul.

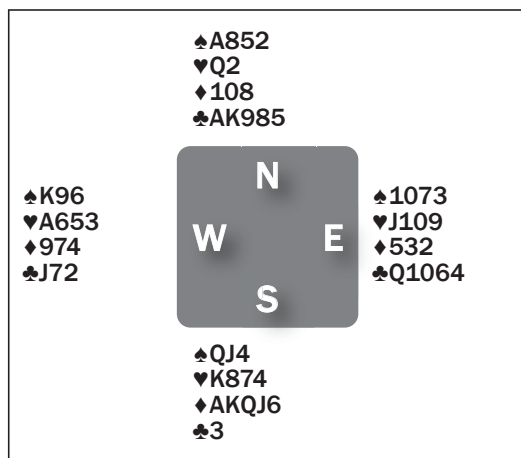

During the same session of the Mixed Pairs final, the Dutch pairing of Huub Bertens and Martine Verbeek reached a horrible 6♦ on the N/S cards. On a non-diamond lead declarer could at least have taken a heart ruff in the dummy, giving some chances, but West did lead a trump, and now Verbeek had to work very hard to find a line to give her any hope at all.

Verbeek won dummy’s eight of diamonds and played three rounds of clubs, pitching a spade on the king then ruffing high. A diamond to the ten allowed a second club ruff, setting up the fifth card as an extra winner. On this trick West made a crucial error, when he discarded a spade. Verbeek continued with the queen of spades to the king and ace, came back to the jack and cashed her last trump. Now a heart to the queen provided an entry to the long club, on which Verbeek threw a heart, and East was squeezed between the jack-ten of hearts and ten of spades. When she discarded a heart, praying that her partner would hold the eight, Verbeek could play the two of hearts and West had to give her the last trick in the suit for her contract.

This rare ending was named a vice squeeze by the late great Terence Reese.

Board 15. Dealer South. E/W Vul.

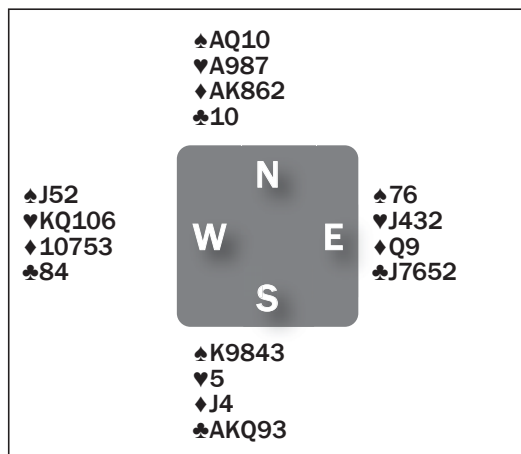

This deal from the Open Teams was one of the highlights of the tournament and was originally covered for the daily Bulletin by Patrick Jourdain. Several N/S pairs bid to the spade grand slam, but not all found the way home. Sweden’s Per-Erik Austberg and Jan-Torre Berg were one of the successful pairs.

West led the king of hearts to dummy’s ace. Austberg took two top spades then played ace of clubs and ruffed a club, ruffed a heart to get back to hand and drew the last trump, pitching a diamond from dummy. East realised that declarer had five clubs so pitched a heart. However, Austberg now crossed to the ace of diamonds to ruff another heart, then cashed the two club winners. With West the only one guarding the hearts, he was squeezed in the red suits to give the thirteenth trick.

Romania’s Marius Ionita and Marina Stegariou also reached 7♠ and the lead was again the king of hearts. Play followed the same line as before up to the point at which we have seen East throw a fatal heart. England’s Tom Townsend saw the impending squeeze on his partner so found the better discard of the nine of diamonds, retaining his heart holding. Ionita, however, found the answer. He led the jack of diamonds to the ace, felling the queen, then ruffed a heart as before. When Ionita next cashed the two club winners, West had to throw a heart and a diamond. Reading the ending perfectly, Ionita led the four of diamonds to dummy’s eight and he too had made his grand slam.

Board 6. Dealer East. E/W Vul.

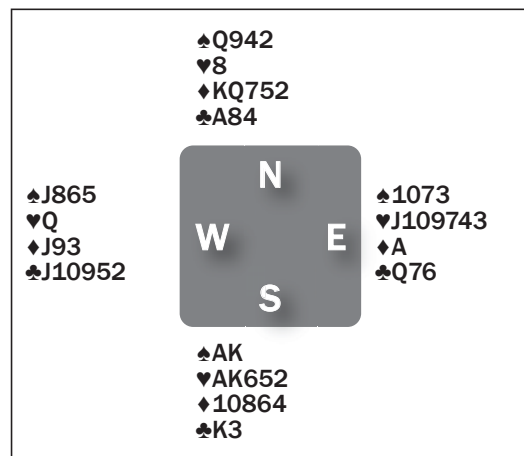

West	North	East	South
Tuszynski	Meckstroth	Gawryls	Rodwell
–	–	2♦ <sup>(i)</sup>	Dble
2♥	3♠	Pass	3NT
All Pass			

<sup>(i)</sup> Multi

Eric Rodwell brought home this tricky 3NT in the KO stages of the Open Teams. He received the lead of the jack of clubs and won it in hand with the king. Naturally enough, he now failed to guess the diamond position and led a diamond to the king and ace. East returned the queen of clubs, ducked, and another club to the ace. Superficially, declarer’s position is hopeless, but Rodwell proved that was not the case. He

cash the ace and king of spades and heart ace to leave this position:

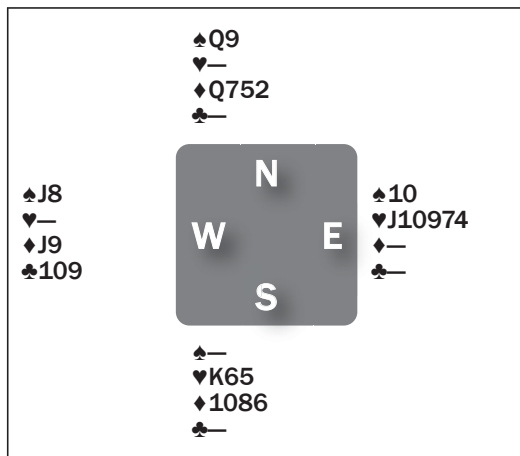

When Rodwell now cashed the king of hearts, West had no winning play. If he threw a spade the nine would become declarer's ninth trick, while a diamond would give the whole diamond suit. In practice, Gawrys threw a club, but now Rodwell could afford to concede a diamond as there was only one club to be cashed, and again had his ninth trick.

Board 27. Dealer South. None Vul.

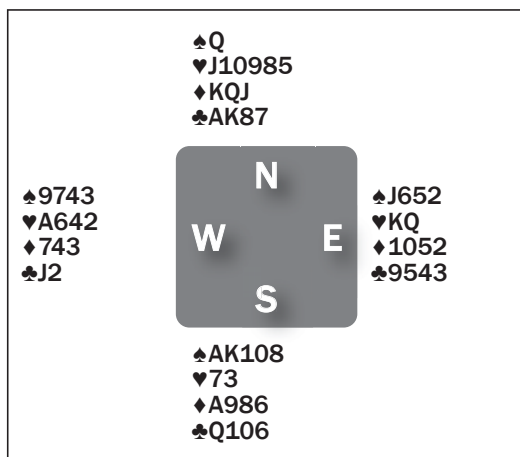

The eventual winners of the Open Pairs, Sabine Auken and Roy Welland, reached 3NT from the South seat on this deal

from the qualifying stage. West led a diamond against Auken. She cashed three rounds of diamonds, unblocked the queen of spades, came to hand with the queen of clubs, and cashed the fourth diamond. Dummy and West threw hearts, but East erred when he threw a spade, relying on his partner to hold the ten.

Now Auken cashed three more spades and East was squeezed for a second time. Hanging on grimly to his club stopper, he pitched a heart honour. Auken cashed the ace and ten of clubs and exited with a heart. The defence was caught – if West played low East would win the king but then have to give the last trick to the king of clubs, so he went up with the ace, but now his six of hearts had to be led to declarer's seven at trick thirteen. That was the twelfth trick for a huge matchpoint score. The technique involved was, of course, a stepping stone squeeze.

## Daily Play Problem 2 – Solution

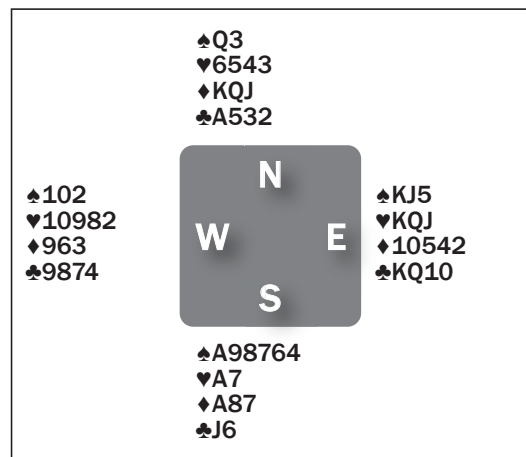

You can be pretty sure that all the keycards are located with East since you only miss 15 HCP. With this knowledge we therefore can forget about playing a low spade towards dummy's queen hoping that the king would be with West. With a club and a hearts loser we can't afford to lose two tricks in trumps.

A reasonable layout of the hand is what's suggested above. If that's the case, we could play the trump suit with only one loser. Win the heart that was led, and run the nine of spades. If West covers you play the queen and finesse East for the jack next time. If West plays low, you finesse and allow East to win with the jack. Later on enter dummy and call for the queen of trumps, East has to cover and you also bring down the ten, solving the suit and making the contract.

### CHANGE IN APPEAL PROCEDURE

The Review Procedure as outlined in Section 9 of the Supplemental Conditions of Contest will NOT apply to these championships, and will be replaced by the regular Appeals Procedure as outlined in Sections 32–35 of the EBL General Conditions of Contest.

<http://www.eurobridge.org/Repository/Documents/EBLGeneralCoC2013.pdf>  
The deposit for an appeal (Section 34.2) is EUR 100.



# Pierwsze śliwki...

Marek Wójcicki

Wbrew popularnemu przysłowiu nie były to „robaczywki”. Co prawda pierwszy mecz zakończył się wynikiem 38-45 (8,17-11,83 według nowej skali VP, obowiązującej w mistrzostwach), ale zwycięstwo Francuzów było dość szczęśliwe.

Mecz był trudny i stał na dobrym poziomie. Obie drużyny zaprezentowały agresywną grę, typową dla juniorów, ale popartą przyzwoitą techniką.

Popatrmy chociażby na poniższe rozdanie:

Rozd. 12. NS po, rozd. W

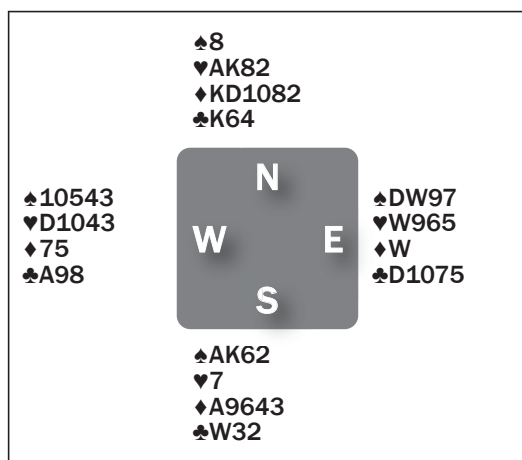

Na wielu stołach NS dochodzili do szlemika w karo nie niepokojeni przez obrońców, po licytacji na przykład takiej, jak w meczu Dania – Szwecja:

	N	S
	Bilde	Jepsen
	1♦	1♠
	2♥	4♦
	4♥	4♠
	4BA	5♥
	6♦	pas...

W meczu naszych nie było tak lekko, na żadnym ze stołów. Polska para na linii WE pierwsza zabrała głos w licytacji, ale przeciwnicy sobie poradzili i zdołali dojść do szlemika:

W	N	E	S
Jassem	Bernard	Wojcieszek	Kilani
2♣ <sup>1)</sup>	2♦	3♠	4♠
pas	4BA	pas	5♥
pas	6♦	pas...	

<sup>1)</sup> poniżej otwarcia, co najmniej 4-4 w starszych...

Na drugim stole Francuzi mieli do dyspozycji podobny gadzet:

W	N	E	S
Coudert	Klukowski	Lorenzini	Tuczyński
2♥ <sup>1)</sup>	3♦	3♠	4♥
pas	4BA	pas	5♥
pas	6♦	pas...	

<sup>1)</sup> poniżej siły otwarcia, co najmniej 4-4 w starszych

ale nie przeszkodził on naszym w dojściu do szlemika. Oczywiście na obu stołach, dzięki dobremu położeniu asa trefl, wzięto bez problemu 12 lew.

Za chwilę tracimy 13 imp po nietrafieniu palcówki rozgrywkowej przez Tuczyńskiego, ale odrabiamy dwa rozdania później 12 imp dzięki lepszej licytacji pary Klukowski – Tuczyński:

Obie przed, rozd. N

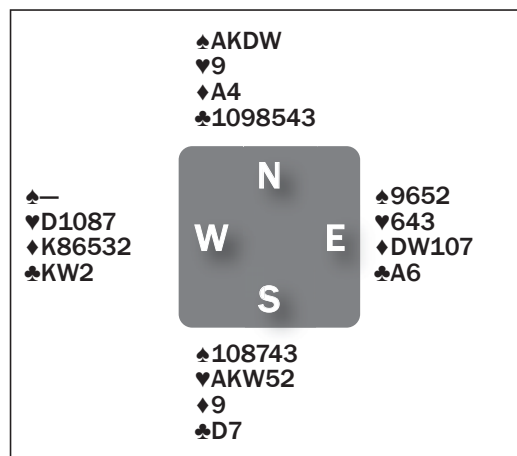

W	N	E	S
Coudert	Klukowski	Lorenzini	Tuczyński
3♦	1♣	pas	1♠
pas	4♦	5♦	5♥
	5♠	pas...	

Swoje, a na drugim stole 6♠ bez trzech...

## MEAL TIMES

Meal times in the hotel are as follows:

Breakfast: 7.00 – 10.00

Lunch: 12.30 – 13.30

Dinner: 19.30 – 21.30

Niestety, w ostatnim rozdaniu Francuzi z rękami:

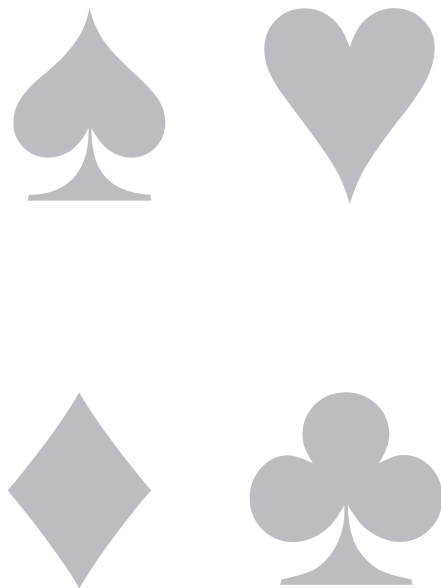
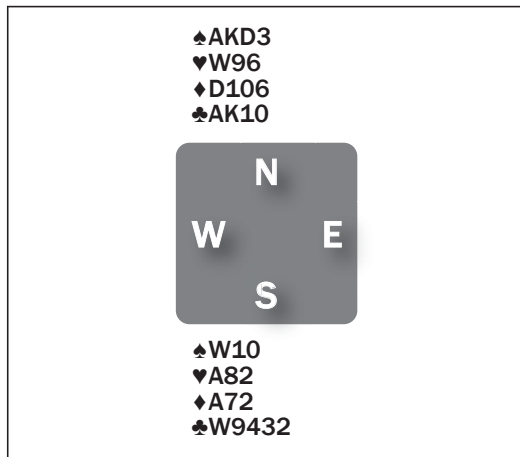

dochodzą do mocno naciągniętych 6♣. Wojcieszek (E) atakuje nieszczęśliwie spod króla z waletem karo, i rozgrywający dzięki spadającej singlowej damie trefl za impasem wygrywa kontrakt. Nasi słusznie zatrzymują się w 3BA i tracimy 12 imp.



## 19<sup>th</sup> SWEDISH BRIDGEFESTIVAL ÖREBRO, July 26<sup>th</sup> - August 4<sup>th</sup> 2013

- The Chairman's Cup • 6 National Championships
- 29 Bronze Tournaments • 7 Silver Tournaments
- 1 Gold Mine • 1 80th Anniversary Competition
- 5 Seminars for Beginners • PartyNight with Dance • Vugraph
- Daily Bulletin • Master Points and Cash Prizes in all Tournaments

7778 pairs in 2012. Take part in one of the Worlds largest and best Bridgefestivals!

All information to be found at [www.svenskbridge.se/festival](http://www.svenskbridge.se/festival)



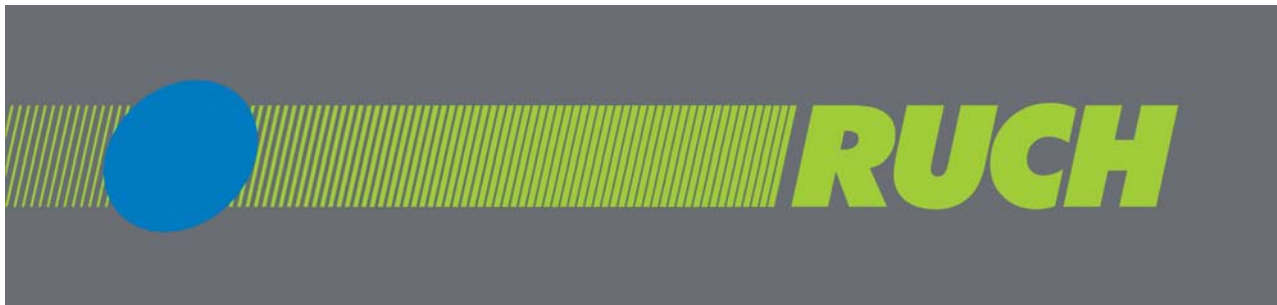

### **RUCH read a new**

RUCH is one of the most recognizable brands in Poland. Its history dates back to 1918, which means that it is 95 years of age. Today RUCH is a privately held company that is currently undergoing dynamic transformation aimed at matching the business with the needs of customers across the country. The changed logo and new kiosk cubes make the external sign of many changes that are currently taking place in the company. The new model of kiosks is a synonym of modernity, openness to the contacts with customers and immediate reaction to their spontaneous needs.

### **Listening to the rhythm of millions**

RUCH's network of sales is built so as to be able to satisfy basic but pressing needs of our customers at each step. Purchasing press, tickets, morning coffee or snacks, that is activities we usually do not want to devote too much time to and that we do without prior planning, may be done in a an easier and faster way. While designing a new kiosk, we tried to make even the quick way of shopping for small products pleasant. The new kiosk cube is wide open, products are easily accessible and well displayed, and the contact with the assistant has been made comfortable.

Kiosk is a coffee corner. Coffee is grounded and percolated in high quality vacuum coffee makers on the spot. Customers can also buy sandwiches and snacks. All these features have contributed to the new model of RUCH kiosks being recognized as an innovation on the Polish market.

### **In rhythm of space**

Over the years RUCH has melted into the landscape of Polish cities. It has changed and is still changing with them. New selling points of RUCH are characterized with a modern design that ideally meets the architectural requirements of contemporary metropolis and developing towns. The graphite colour of the kiosks constitutes a neutral background matching the urban architecture and making it possible to effectively display merchandise. The changed stylistics of the RUCH trademark possesses modern and dynamic character. The attractive set of colours attracts attention. The name, the type font and characteristic shade of green refer to the nearly 100-year tradition of RUCH.

### **Need of a place**

The retail network has been divided into four segments. Each of these segments provides customers with an offer tailored to the place where they are in a given moment. Except for the so-called basic assortment, kiosks offer characteristic merchandise that is useful in this specific location. Cigarettes, magazines and tickets are sold in busy places; books, gifts and postcards are sold at airports and train stations; an extensive range of weeklies and magazines may be found in shopping centres whereas public utility facilities offer sandwiches or intermediate products that make it possible to prepare a quick meal.

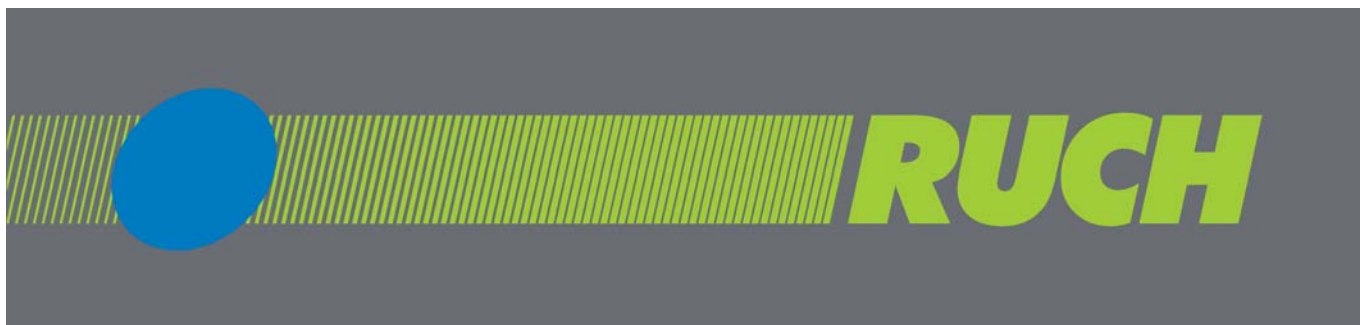

**budimex**

**GEMi**  
HOTEL\*\*\*

**RAG**  
PRETZEL STICKS

**N** Catering & Restaurants  
**NELSON**  
Prestige • Grade • Moments

**Staropolanka**<sup>®</sup>  
naturalna woda mineralna

**NEONET**